

Test Report: Qualification Report Various Topologies

Document: 08690416

Issue: 1

Date: 10th April 2026

Page: 1 of 176

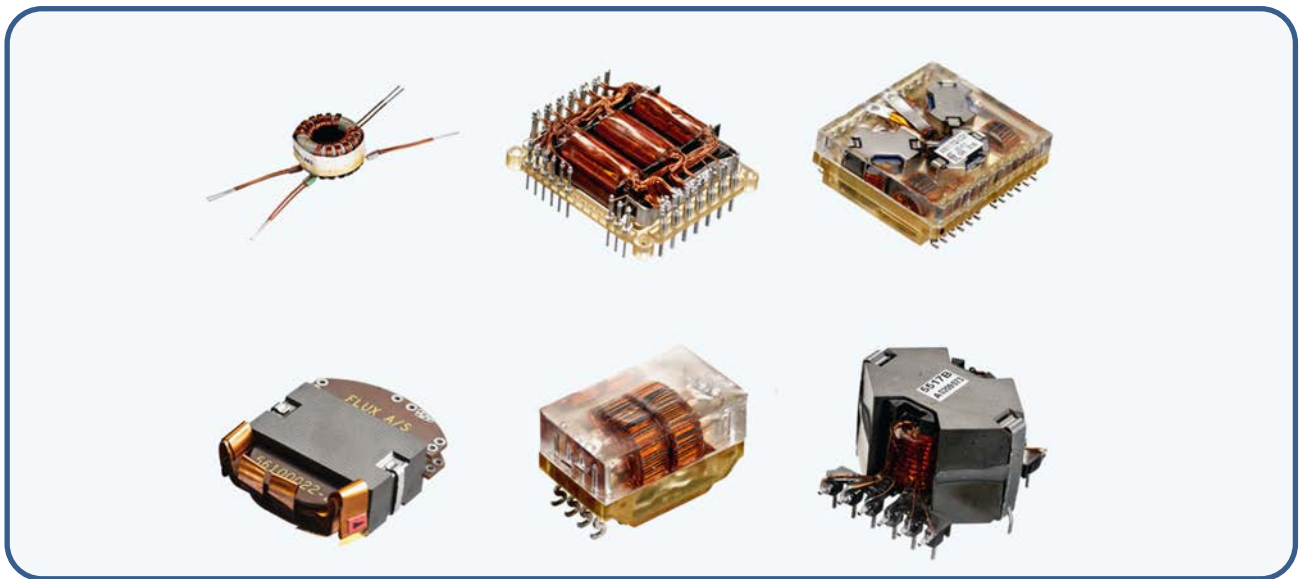

Author



Michael D. Simpson

**Chief Operating Officer
(Defence and Space)**

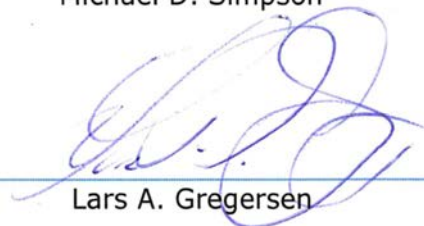

Lars A. Gregersen

© Flux A/S

This document contains information proprietary to Flux A/S. The information, whether in form of text, schematics, tables, drawings or illustrations, must not be duplicated or used for purpose other than evaluation, or disclosed outside the recipient company or organisation without the prior, written permission of Flux A/S.

DOCUMENT CHANGE LOG

Change No.	Date	Initiator	Pages Affected	Short Description of Change

TABLE OF CONTENTS

1. INTRODUCTION	8
2. REFERENCE DOCUMENTS	8
3. SAMPLES DEFINITION	8
3.1 Range of component families for testing	8
4. QUALIFICATION AND VERIFICATION TESTING	10
4.1 Original subgroups	10
4.2 Modified test flow	11
4.3 Test facilities	11
5. TEST METHODS AND REQUIREMENTS	12
5.1 Screening	12
5.2 Electrical characteristics	12
5.2.1 Electrical characteristics test method	12
5.2.2 Electrical characteristics requirements	12
5.3 Visual inspection	12
5.3.1 Visual inspection method	12
5.3.2 Visual inspection requirements	12
5.4 Thermal Shock	13
5.4.1 Thermal shock method	13
5.4.2 Thermal shock requirement	13
5.5 Dielectric Withstanding Voltage	13
5.5.1 Dielectric withstanding voltage method	13
5.5.2 Dielectric withstanding voltage requirements	14
5.6 Solderability	14
5.6.1 Solderability method	14
5.6.2 Solderability requirements	14
5.7 Resistance to solvent	14
5.7.1 Resistance to solvent method	14
5.7.2 Resistance to solvent requirements	14
5.8 Terminal strength	14
5.8.1 Pull method	14
5.8.2 Terminal strength requirements	15
5.9 Permanence of marking	15
5.9.1 Permanence of marking method	15
5.9.2 Permanence of marking requirements	15
5.10 Vibration	16
5.10.1 Vibration test method	16
5.10.2 Vibration test requirements	16
5.11 Mechanical Shock	17
5.11.1 Mechanical shock method	17

5.11.2	Mechanical shock requirements.....	17
5.12	Moisture resistance	17
5.12.1	Moisture resistance method	17
5.12.2	Moisture resistance requirements.....	17
5.13	Overload.....	17
5.13.1	Overload method	17
5.14	Temperature rise	17
5.14.1	Temperature rise method.....	17
5.15	Life test	18
5.15.1	Life test method.....	18
5.15.2	Life test requirements.....	19
5.16	Partial discharge	19
5.16.1	Partial discharge Method	19
5.17	Insulation resistance	19
5.17.1	Insulation resistance method.....	19
5.17.2	Insulation resistance requirements	19
5.18	Visual and Mechanical Examination (DPA)	19
5.18.1	Visual and Mechanical Examination method	19
5.18.2	Visual and Mechanical Examination Pass Criteria	19
6.	ACCEPT / REJECT CRITERIA	19
7.	FAILURE ANALYSIS	20
8.	ACCEPT/REJECT CRITERIA	20
9.	TEST RESULTS	20
9.1	Presentation of results.....	20
9.2	Vibration and Mechanical Shock.....	21
9.2.1	Random Vibration	21
9.2.2	Mechanical Shock 500g.....	22
9.3	Moisture Test	23
9.3.1	One cycle	23
9.3.2	Full Test.....	24
9.4	Operating life	24
9.5	Overload.....	25
9.6	Partial discharge.....	25
9.7	Thermal shock method	26
9.8	Internal Examination (DPA).....	27
9.8.1	Q1 – ESCC320101301F12009014-1.....	27
9.8.2	Q2 - ESCC320101301F14790302-1 Pending	27
9.8.3	Q3 – 14391017-1-B	28
9.8.4	Q4 – 12000096-1-B	28
9.8.5	Q5 – ESCC320101301F14809024-1.....	29

9.8.6	Q6 – ESCC320101399F14229012-1.....	29
9.8.7	Q7 – Not used	30
9.8.8	Q8 – ESCC320101301F14121040-1.....	30
9.8.9	Q9 – ESCC320101301F12385000-1.....	31
9.8.10	Q10 – ESCC320101301F14179033-1	31
9.8.11	Q11 – 12251055-1-B.....	32
9.8.12	Q12 – 12141076-3-B.....	32
9.8.13	Q13 – 12311081-1-B.....	33
9.8.14	Q14 – 12011041-1-B.....	33
9.8.15	Q15 – 14110319-1-B.....	34
9.8.16	Q16 – 14170338-2-B.....	34
9.8.17	Q17 – 14220171-1-B.....	35
9.8.18	Q18 – ESCC320101301F12180007-2.....	35
9.8.19	Q19 – ESCC320101301F12011018-*	36
9.8.20	Q20 – ESCC320101301F14110308-1	36
9.8.21	Q21 – ESCC320101301F14230080-2 Pending.....	37
9.8.22	Q22 – 14890203-1-B.....	37
9.8.23	Q23 – 12248004-1-B.....	38
9.8.24	Q24 – 14241039-1-P.....	38
9.8.25	Q25 – 12411058-1-P.....	39
9.8.26	Q26 – 12411057-1-P.....	39
9.8.27	Q27 – 12141123-1-P.....	40
9.8.28	Q28 – 12011044-1-P.....	40
9.8.29	Q29 – ESCC320101301F12939014-1	41
9.8.30	Q30 – 19210136-1-B.....	41
9.8.31	Q31 – 14110323-1-B Pending.....	42
9.8.32	Q332 – 14110323-1-B Pending	42
9.9	Observations and Observations on testing	43
9.10	Minor Nonconformances	43
9.11	Critical Failures.....	43
10.	CONCLUSION.....	43
11.	TEST DATA.....	44
11.1	Q01 – 12009014-1-C	45
11.2	Q2 - ESCC320101301F14790302-1 Pending.....	48
11.3	Q3 – 14391017-1-B	51
11.4	Q4 – 12000096-1-B	54
11.5	Q5 – 14809024-1-C	57
11.6	Q06 – 14229012-1-C	60
11.7	Q07 – Not used	64
11.8	Q08 – 14121040-1-C	68

11.9	Q09 - 12385000-1-C	72
11.10	Q10 - 14179033-1-C	75
11.11	Q11 - 12251055-1-B	78
11.12	Q12 - 12141076-3-B	81
11.13	Q13 - 12311081-1-B	84
11.14	Q14 - 12011041-1-B	87
11.15	Q15 - 14110319-1-B	90
11.16	Q16 - 14170338-2-B	93
11.17	Q17 - 14220171-1-B	96
11.18	Q18 - 12180007-2-C	99
11.19	Q19 - 12011018-5-C	102
11.20	Q20 - 14110308-1-C	105
11.21	Q21 - ESCC320101301F14230080-2-C	108
11.22	Q22 - 14890203-1-B	111
11.23	Q23 - 12248004-1-B	114
11.24	Q24 - 14241039-1-P	117
11.25	Q25 - 12411058-1-P	121
11.26	Q26 - 12411057-1-P	124
11.27	Q27 - 12141123-1-P	127
11.28	Q28 - 12011044-1-P	130
11.29	Q29 - 12939014-1-C	133
11.30	Q30 - 19210136-1-B	136
11.31	Q31 - 14110323-1-B (CV10-2500) Pending	139
11.32	Q32 - 14110323-1-B (Arathane 5750) Pending	142

12. PARTS AND PART MOUNTING 145

12.1	Q1 - ESCC320101301F12009014-1	145
12.2	Q2 - ESCC320101301F14790302-1 pending	146
12.3	Q3 - 14391017-1-B	147
12.4	Q4 - 12000096-1-B.....	148
12.5	Q5 - ESCC320101301F14809024-1	149
12.6	Q6 - 14229012-1-P.....	150
12.7	Q7 - Not used	151
12.8	Q8 - ESCC320101301F14121040-1	152
12.9	Q9 - 12385000-1-B.....	153
12.10	Q10 - ESCC320101301F14179033-1-C	154
12.11	Q11 - 12251055-1-B	155
12.12	Q12 - 12141076-3-B.....	156
12.13	Q13 - 12311081-1-B.....	157
12.14	Q14 - 12011041-1-B.....	158
12.15	Q15 - 14110319-1-B	159

12.16	Q16 - 14170338-2-B.....	160
12.17	Q17 - 14220171-1-B	161
12.18	Q18 - ESCC320101301F12180007-2-C	162
12.19	Q19 - ESCC320101301F12011018-*-C	163
12.20	Q20 - ESCC320101301F14110308-1-C	164
12.21	Q21 - ESCC320101301F14230080-2-C Pending	165
12.22	Q22 - ESCC320101301F14890203-1-C	166
12.23	Q23 - 12248004-1-B	167
12.24	Q24 - 14241039-1-P	168
12.25	Q25 - 12411058-1-P	169
12.26	Q26 - 12411057-1-P	170
12.27	Q27 - 12141123-1-P	171
12.28	Q28 - 12011044-1-P	172
12.29	Q29 - ESCC320101301F12939014-1-C	173
12.30	<u>Q30</u> - 19210136-1-B	174
12.31	Q31 - 14110323-1-B (CV10-2500) Pending	175
12.32	Q32 - 14110323-1-B (Arathane 5750) Pending	176

1. INTRODUCTION

This reports the Qualification, Periodic Testing and LOT Validation of parts within the Technology Domain of the Flux A/S Technology Flow Approval. Testing is performed in line with 3201/013. The components under test were defined in section 3.1

2. REFERENCE DOCUMENTS

Ref.	Document	Title
RD1	FT 08690415	Qualification Test procedure
RD2	MIL-PRF-27	General Specification for Transformers and Inductors
RD3	MIL-STD-202	Test Method Standards – Electronic and Electrical Component Parts
RD4	MIL-STD-981	Design, Manufacturing and Quality Standards for Custom Electromagnetic Devices for Space Applications
RD5	FT08711502	Screen Testing
RD6	FT08699003 and FT08690027	ESCC Declared Materials List Generic Declared Materials List
RD7	FT08699004 and FT08690028	ESCC Declared Processes List Generic Declared Processes List
RD8	FT08699015	Technology Flow
RD9	FT08690415	Qualification, Verification and Periodic Testing
RD10	126-22014	Vibration and Shock of Test Components

3. SAMPLES DEFINITION

3.1 Range of component families for testing

These parts were selected as representative of Flux's domain:

Evaluation Sample	Flux Part No	Description	Quantity
Q1	12009014-1-C	EP5 2K Coupled Inductor	5
Q2	14790302-1-C	EFD12 SMD Current Sense	5
Q3	14391017-1-B	I3M 21.1 x 32 x 24	5
Q4	12000096-1-B	Amobead 3-2-3W	5
Q5	14809024-1-C	RF Transformer	5
Q6	14229012-1-C	1:20 HV TRSF	5
Q8	14121040-1-C	20W 63V Transformer	5
Q9	12385000-1-C	100µH 20A	5
Q10	14179033-1-C	Flyback Transformer	5
Q11	12251055-1-B	Power Inductor	5
Q12	12141076-3-B	Input Inductor	5
Q13	12311081-1-B	Super Buck Inductor	5
Q14	12011041-1-B	APR Aux Input Filter Inductor	5
Q15	14110319-1-B	BCR Gate Drive Transformer	5
Q16	14170338-2-B	FEE DIG Aux Supply Transformer	5
Q17	14220171-1-B	Aux Supply Transformer	5
Q18	12180007-2-C	5µH Inductor with Slave winding	5
Q19	12011018-*-C	Choke 10 Turns	5
Q20	14110308-1-C	Transformer	5

Q21	14230080-2-C	Transformer	5
Q22	14890203-1-B	Flux SMT Gate Transformer	5
Q23	12248004-1-B	Inductor	5
Q24	14241039-1-P	EQ30 Transformer	5
Q25	12411058-1-P	Inductor	5
Q26	12411057-1-P	Inductor	5
Q27	12141123-1-P	Inductor	5
Q28	12011044-1-P	Inductor	5
Q29	12939014-1-C	Flux SMT E22L Inductor Serie	5
Q30	19210136-1-B	CMGE RM10 Assembly	5
Q31	14110323-1-B	Impregnated with (CV10-2500)	5
Q32	14110323-1-B	Impregnated with (CV10-2500)	5

Table 3-1 Test samples

4. QUALIFICATION AND VERIFICATION TESTING

4.1 Original subgroups

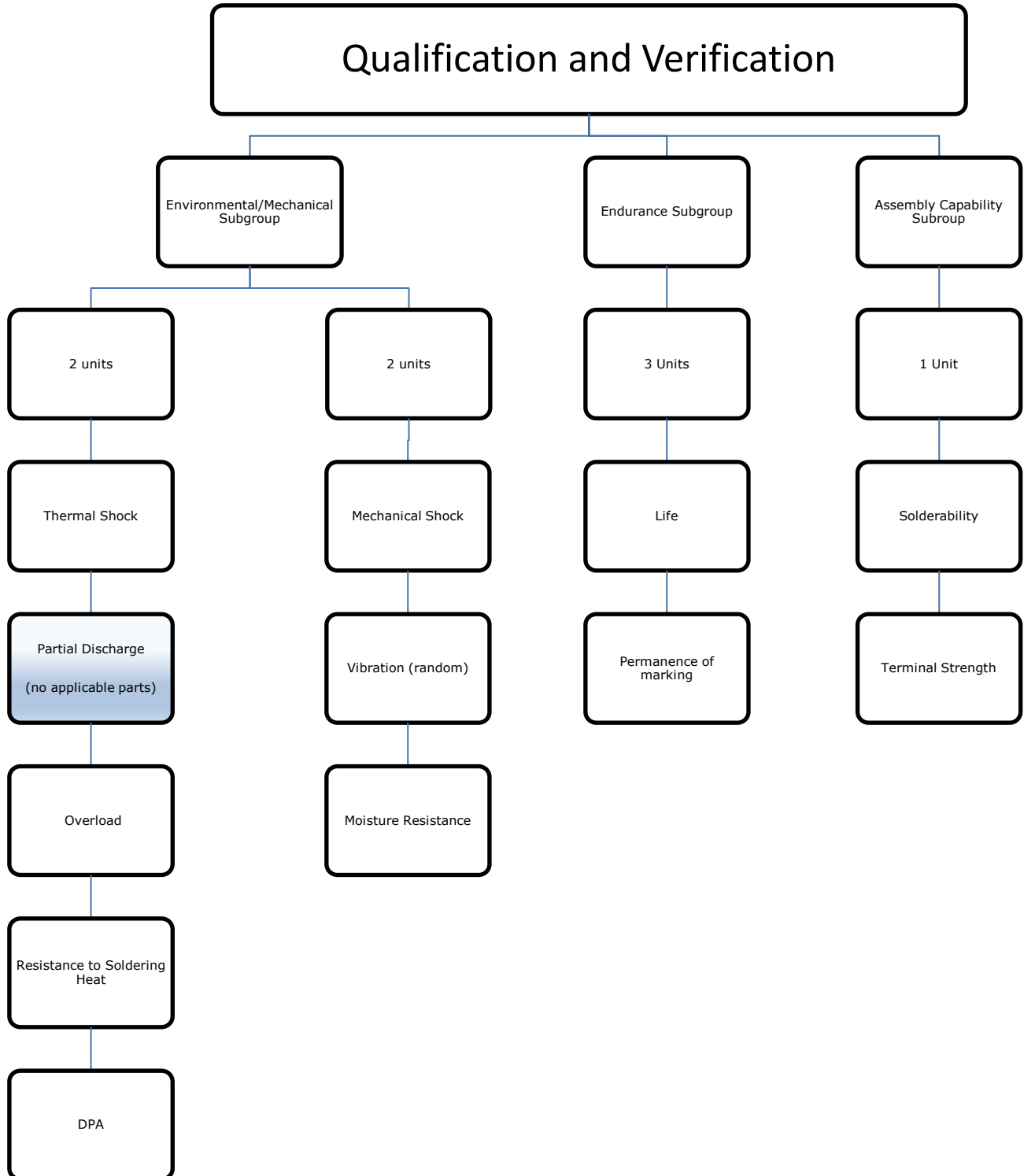

4.2 Modified test flow

Test performed based the requirements of MIL-PRF-27^(RD2) Table V (Qualification Inspection).

Group and Test		Sample					Method (Paragraph)	Requirement (Paragraph)
		1	2	3	4	5		
Group 1	Screening	✓	✓	✓	✓	✓	5.1	
	Solderability	✓	✓	✓	✓	✓	5.6.1	5.6.2
	Terminal Strength	✓	✓	✓	✓	✓	5.8.1	5.8.2
	Visual Inspection	✓	✓	✓	✓	✓	5.3.1	5.3.2
	Electrical characteristics (room temperature)	✓	✓	✓	✓	✓	5.2.1	5.2.2
	Insulation Resistance	✓	✓	✓	✓	✓	5.17.1	5.17.2
	Visual Inspection	✓	✓	✓	✓	✓	5.3.1	5.3.2
Group 2	DWV (at atmospheric pressure) 60s	✓	✓	✓	✓	✓	5.5.1	5.5.2
	Electrical characteristics (room temperature)	✓	✓	✓	✓	✓	5.2.1	5.2.2
	Mounting on PCB and Fixture	✓	✓	✓	✓	✓	ECSS-Q-ST-70-08	
	Visual Inspection	✓	✓	✓	✓	✓	5.3.1	5.3.2
	Electrical characteristics (room temperature)	✓	✓	✓	✓	✓	5.2.1	5.2.2
Group 3	Life test			✓	✓	✓	5.15.1	5.15.2
	Dielectric withstanding voltage (At reduced voltage)			✓	✓	✓	5.5.1	5.5.2
	Electrical characteristics (room temperature)			✓	✓	✓	5.2.1	5.2.2
	Resistance to solvents			✓	✓	✓	5.7.1	5.7.2
	Permanence of Marking			✓	✓	✓	5.9.1	5.9.2
Group 4	Vibration	✓	✓				5.10.1	5.10.2
	Mechanical Shock	✓	✓				5.11.1	5.11.2
	Visual Inspection	✓	✓				5.3.1	5.3.2
	Electrical characteristics (room temperature)	✓	✓				5.2.1	5.2.2
	Moisture resistance	✓	✓				5.12.1	5.12.2
	Electrical characteristics (room temperature)	✓	✓				5.2.1	5.2.2
	Winding continuity	✓	✓				RD6	
	Thermal shock	✓	✓				5.4.1	5.4.2
	Electrical characteristics (room temperature)	✓	✓				5.2.1	5.2.2
	Partial Discharge - if applicable	✓	✓				5.16.1	5.16.2
	Temp Rise (selected units)	✓					5.14.1	5.14.2
	Overload	✓	✓				5.13.1	5.13.2
	Visual and mechanical examination	✓	✓				5.3.1	5.3.2
	Electrical characteristics	✓	✓				5.2.1	5.2.2
	Flammability	Not Applicable						
Visual and Mechanical Examination (DPA)	✓					5.18.1	5.18.2	

Sample Size = 5

Failures Allowed = 0

4.3 Test facilities

All testing was performed at Flux's facilities in Asnaes, Denmark with the exception of Vibration and Mechanical Shock, which was performed at Force in Hørsholm, Denmark.

5. TEST METHODS AND REQUIREMENTS

5.1 Screening

Screening shall be performed in accordance with FT08711502^(RD5) as specified in the detail specifications and the test matrix in table 4-2.

5.2 Electrical characteristics

The applicable electrical characteristics and tolerances shall be as specified on the transformer or inductor manufacturing drawing.

5.2.1 Electrical characteristics test method

Electrical characteristics are defined as inductance, unless specified otherwise. The applicable electrical characteristics for each sample are specified on the detail specifications. Measurements shall be performed in accordance with FT08711502^(RD5) with the test conditions as specified in the detailed specifications.

5.2.2 Electrical characteristics requirements

The measured electrical characteristics shall fall within the limits specified on the detailed specifications. Drift shall be calculated with reference to first measurement after production screening.

5.3 Visual inspection

Visual inspection shall be performed as specified in table 4-2.

5.3.1 Visual inspection method

Visual inspection shall be aided by magnification appropriate to the size of inspection item, between 4x to 10x magnification. Additional magnification shall be used to resolve suspected anomalies or defects.

5.3.2 Visual inspection requirements

5.3.2.1 External

The qualification models shall be examined to verify that the materials, external design and construction, physical dimensions, marking and workmanship are in accordance with the requirements defined in the relevant procedures and the applicable documents given in chapter 2.

5.3.2.2 Post-test

Not more than 10% of the surface shall have pooling, flaking, chipping, cracking, crazing or other impairment of the protective coating. There shall be no leakage of the filling material, no evidence of other physical damage, such as cracks, bursting, or bulging of the case or corrosion affecting the mechanical or electrical operation of the samples in accordance with MIL-PRF-27^(RD2).

5.4 Thermal Shock

5.4.1 Thermal shock method

Thermal shock shall be performed using an environmental chamber. The following test conditions shall be used:

Test Conditions	
Minimum temperature	- 55°C ±3°C
Maximum temperature	+120°C ±3°C
Transition temperature	Room Temperature
Dwell time at min. and max. temperature	30 min.
Dwell time at transition temperature	4 min.
Transfer time	<5 min.
Number of cycles	100

Table 5-1 Thermal Shock

The first five cycles shall be run continuously. After five cycles, the test may be interrupted after the completion of any full cycle, and the components allowed returning to room ambient temperature before testing is resumed.

5.4.2 Thermal shock requirement

The components shall be examined for evidence of leakage and other visible damage.

5.5 Dielectric Withstanding Voltage

Atmospheric pressure is applicable for all components

5.5.1 Dielectric withstanding voltage method

The Dielectric Withstanding Voltage (DWV) test, serves to determine whether insulating materials and spacing between different parts in the magnetic component are adequate.

The test consists of the application of an AC voltage higher than rated voltage for a specific time between mutually insulated portions of a component part or between insulated portions and ground.

The test shall be applied between each winding and shield, and all of the other windings and shields connected to the core (if accessible). Alternatively, the test shall be applied between each winding and shield, and each of the other windings, shields and core (if accessible).

As the test is deemed destructive, the test will be performed at 100% on the first occasion and 75% thereafter.

Atmospheric pressure applies

<i>Voltage</i>	<i>As applicable for the individual design</i>
<i>Max. Current</i>	<i>As applicable for the individual design</i>
<i>Ramp Time</i>	<i>Max. 1 s</i>
<i>Dwell Time</i>	<i>Min. 60 s for qualification</i> <i>Min. 5 s for validation</i>
<i>Frequency</i>	<i>50 Hz</i>

5.5.2 Dielectric withstanding voltage requirements

During and after the test the magnetic device shall be inspected for evidence of arcing, flashover, breakdown of insulation, and damage.

5.6 Solderability

Solderability shall be performed on samples with PCB terminals. Solderability is not applicable for flying leads.

5.6.1 Solderability method

Solderability shall be tested by the "Soldering iron method", specified in MIL-STD-202, method 208. By using the "Soldering iron method" no separate test for resistance to soldering heat will be performed, and the purpose of this test will be:

- a) Qualification of the component resistance to heat when soldered with a soldering iron.
- b) Qualification of the solderability of the component terminals.

Practical test method to be applied:

- Minimum two of each type of terminals shall be tested
- A standard soldering iron shall be used. Tip temperature shall be 320 °C +/- 10 °C
- Solder alloy shall be Sn63Pb37 and flux shall be type RMA.
- The solder tip shall be held on the middle of the terminal for 2 Sec +/- 0,5 sec
- Solder iron tip shall be calibrated to reach 280°C on the calibration wire in 2 sec

5.6.2 Solderability requirements

The pins shall be visually inspected. Any termination that has less than 5% of the examination area dewetted, nonwetted or with pinholes will be accepted. Inspection is in accordance with MIL-STD-202 ^(RD3), method 208.

5.7 Resistance to solvent

Not applicable when resistance to solvent data is available. This data is available for the labels used by FLUX, as confirmation FLUX will subject 10 labels to test. These labels will be affixed to dummy units and tested as follows.

5.7.1 Resistance to solvent method

Components shall be tested in accordance with MIL-STD-202 ^(RD3), method 215.

The following shall apply:

- The marked portion of the components shall be brushed.
- The solvents tested shall be:
 - Demineralized water
 - 2-propanol (IPA)

5.7.2 Resistance to solvent requirements

Not more than 10 % of the surface shall have peeling, flaking, cracking or corrosion affecting the mechanical or electrical operation of the component.

5.8 Terminal strength

Up to a maximum of 4 identical terminals per sample is to be subjected to terminal strength test. Terminal strength test is not applicable for flying leads.

For heavy units where additional fixation is used, this test may be waived.

5.8.1 Pull method

The components shall be tested in accordance with MIL-STD-202, method 211. The following details shall apply:

A force shall be applied in the direction of the axis of the termination. The force shall be gradually applied up to 10 N and this force shall be held for 5 – 10 seconds.

5.8.2 Terminal strength requirements

After each test the terminals shall be examined for loosening and rupturing and other mechanical damage. Unless otherwise specified, all terminals on each test sample shall be subjected to the above-mentioned tests, up to a maximum of four identical terminals per sample.

5.9 Permanence of marking

5.9.1 Permanence of marking method

Components shall be tested using the methods detailed MIL-STD-202, method 215.

The following shall apply:

- The marked portion of the components shall be brushed.
- The solvents tested shall be:
 - Demineralized water
 - 2-propanol

5.9.2 Permanence of marking requirements

There shall be no evidence of mechanical damage, and the markings shall remain legible. The paint or exterior finish shall not soften, peel, or show other signs of deterioration.

5.10 Vibration

Components from subgroup 3 shall be exposed to vibration test. The components shall be mounted on PCB's.

5.10.1 Vibration test method

The components shall be mounted on PCBs on vibration fixture. The components shall be exposed to random vibration according to MIL-STD-202 ^(RD3), method 214, condition H.

Test conditions are as follows:

Random vibration
 Vibration level: 30 g rms.
 Duration: 5 minutes per axis.
 Level applied to fixture.

Axis	Frequency Range (Hz)	Level	G rms. Acceleration	Duration per axis
X,Y,Z	20 -100	+ 6 dB/oct	30	300 sec.
	100-1600	0.5 g ² /Hz		
	1600-2000	- 12 dB/oct		

Table 5-3 Vibration Test Level

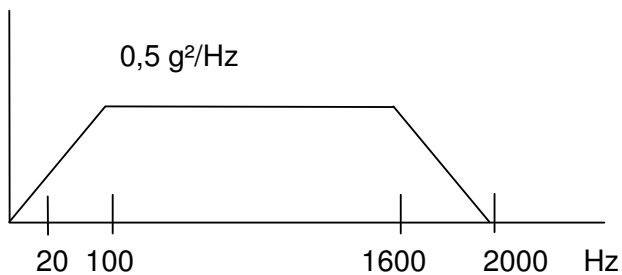

Table 5-4 Vibration test PSD spectrum

5.10.2 Vibration test requirements

There shall be no evidence of physical damage.

5.11 Mechanical Shock

5.11.1 Mechanical shock method

The components shall be mounted on a PCB and a vibration fixture. The components shall be exposed to three shocks in each direction of the three perpendicular axes.

Due to the high demands of space industry, FLUX has elected to increase the demands specified by MIL-PRF-27^(RD2), which states the units be tested accordance with MIL-STD-202^(RD2), method 213 condition I which has a peak value of 100g shock with a sawtooth shape.

To this end, FLUX has decided that the peak value of the shocks is to be 500g with a half sine shape in accordance with MIL-STD-202^(RD2), method 213 condition D Mechanical shock requirements.

5.11.2 Mechanical shock requirements

There shall be no evidence of physical damage.

5.12 Moisture resistance

5.12.1 Moisture resistance method

Moisture resistance is to be performed by exposing the components to a number of temperature and humidity cycles as specified in MIL-STD-202^(RD2), method 106F. The components are not to be polarised or loaded during humidity cycles. Cycle steps 7a (-10°C conditioning) and 7b (vibration) are not applicable.

5.12.2 Moisture resistance requirements

There shall be no evidence of physical damage, or corrosion affecting the mechanical or electrical operation of the component.

5.13 Overload

5.13.1 Overload method

Overload test is performed by applying operating conditions as specified for each component, with the following exceptions:

- Input voltage is to be at 112% of normal input voltage⁽¹⁾
- Temperature: +105° C - 5° C +0°C

Note 1: where applicable

The operating conditions are applied for at least 48h.

5.14 Temperature rise

This test will be performed when requested by the customer.

5.14.1 Temperature rise method

The temperature rise of components shall be determined by any suitable method, but preferably by the resistance-change method.

5.15 Life test

5.15.1 Life test method

Operating Life: Unless otherwise specified, shall be replaced by either Passive Life or Operating Life, as specified in the magnetic sheet for the component under test, as follows:

5.15.1.1 Passive life

MIL-STD-202, Method 108 with the following details:

- Mounting: the components shall be mounted on racks or on a PCB
- Duration:
 - 2000 (+48 -0) hours for Qualification Testing, and Periodic Testing for renewal of qualification after lapse.
 - 1000 (+48 -0) hours for Periodic Testing for extension of qualification Ambient test temperature: maximum operating temperature as specified in Maximum Ratings
- Operating conditions: Non-operating
- Data points:

Intermediate and End-Point Electrical Measurements shall be performed as specified in the Magnetic Sheet for the component under test at 0, and 1000 hours. If drift values are specified, the drift shall always be related to the 0-hour measurement.

The components shall be stabilised at ambient room conditions for a minimum of 30 minutes after removal from the test chamber, prior to the performance of measurements.

On completion of testing, the components shall be visually examined. There shall be no evidence of any damage.

5.15.1.2 Operating life

MIL-STD-202, Method 108 with the following details:

- Mounting: the components shall be mounted on racks or on a PCB
- Duration:
 - 2000 (+48 -0) hours for Qualification Testing, and Periodic Testing for renewal of qualification after lapse.
 - 1000 (+48 -0) hours for Periodic Testing for extension of qualification.
- Operating conditions: 5 ON/OFF cycles/week as follows:
 - Cycles 1 to 4: ON for 20 hours: operating at maximum operating temperature as specified in Maximum Ratings, plus OFF for 3 hours: non-operating at $T_{amb} = +22 \pm 3^{\circ}\text{C}$

followed by:

- Cycle 5: ON for 68 hours: operating at maximum operating temperature as specified in Maximum Ratings, plus OFF for 3 hours: non-operating at $T_{amb} = +22 \pm 3^{\circ}\text{C}$

During ON periods, unless otherwise specified in the Magnetic Sheet for the component under test, the component with all normally loaded secondaries loaded with their specified impedances, shall be loaded with 100% rated power as specified detail specification

- Data Points:

Intermediate and End-Point Electrical Measurements shall be performed as specified in the detail specification for the component under test at 0, 1000 and 2000 hours. If drift values are specified, the drift shall always be related to the 0-hour measurement.

The components shall be stabilised at ambient room conditions for at least 30 minutes after removal from the test chamber, prior to the performance of measurements.

5.15.2 Life test requirements

On completion of testing, the components shall be visually examined. There shall be no evidence of any damage.

5.16 Partial discharge

Transformer only – the applicable parts are listed below.

Evaluation Sample	Flux Part No	Description
Q7	14340158-1-C	Fullbridge Transformer

*part not used

5.16.1 Partial discharge Method

- Magnitude of test voltage: 533Vac peak
- Frequency: 50Hz
- Test duration: 10 minutes min (after ramp up / before ramp down)
- Background noise: <2pC
- Pressure: <2Pa
- Pass criteria: no pulse ($\geq 5pC$) during the test duration shall be observed

5.17 Insulation resistance

5.17.1 Insulation resistance method

At specified voltage with insulation resistance (IR) of 7,500 megohms minimum (unless specified otherwise).

5.17.2 Insulation resistance requirements

There shall not be any evidence of physical damage.

5.18 Visual and Mechanical Examination (DPA)

5.18.1 Visual and Mechanical Examination method

The components are to be moulded into adequate material and cut and polished. The cross section cut shall include solderings (if any), and the core. Multiple cutplanes may be necessary. The components are to be visually inspected and photographed.

5.18.2 Visual and Mechanical Examination Pass Criteria

There shall not be any evidence of physical damage of core, wires, coilformer, solderings, and insulation materials or impregnation material.

6. ACCEPT / REJECT CRITERIA

Qualification samples where one or more sample units do not fulfil the requirements for any one or more tests are to be removed and are considered not acceptable. If, however, the cause of the failure can be identified as bad workmanship, wrong handling or similar reasons and is clearly not related to the general performance of material, process or topology, the sample can be considered as acceptable.

7. FAILURE ANALYSIS

All failed components shall be analysed. The depth of the failure analysis shall depend upon the circumstances in which the failure occurred and upon what useful information can be gained. Reverse processing shall be included as an additional test step. As a minimum the failure mode shall be determined in each case. Failed components shall be marked as failed, and marked with the test in which failure was discovered.

8. ACCEPT/REJECT CRITERIA

Lot acceptance samples where one or more sample units do not fulfil the requirements for any one or more tests are to be removed and are considered not acceptable. If, however, the cause of the failure can be identified as bad workmanship, wrong handling or similar reasons and is clearly not related to the general performance of material, process or topology, the sample can be considered as acceptable.

9. TEST RESULTS

9.1 Presentation of results

The results are presented and summarised in herein any remarks relevant to the test campaign are detailed in sections 8.8 through 8.10.

9.2 Vibration and Mechanical Shock

Vibration and Mechanical shock was performed at Force all units passed without comments. The plots shown are extracts from Force Report 125-24089-1^(AD10).

9.2.1 Random Vibration

This was performed on all units from subgroup 3



Curve 1 Exposure curve e.g. X-axis. Similar curve for all axes.

9.2.2 Mechanical Shock 500g

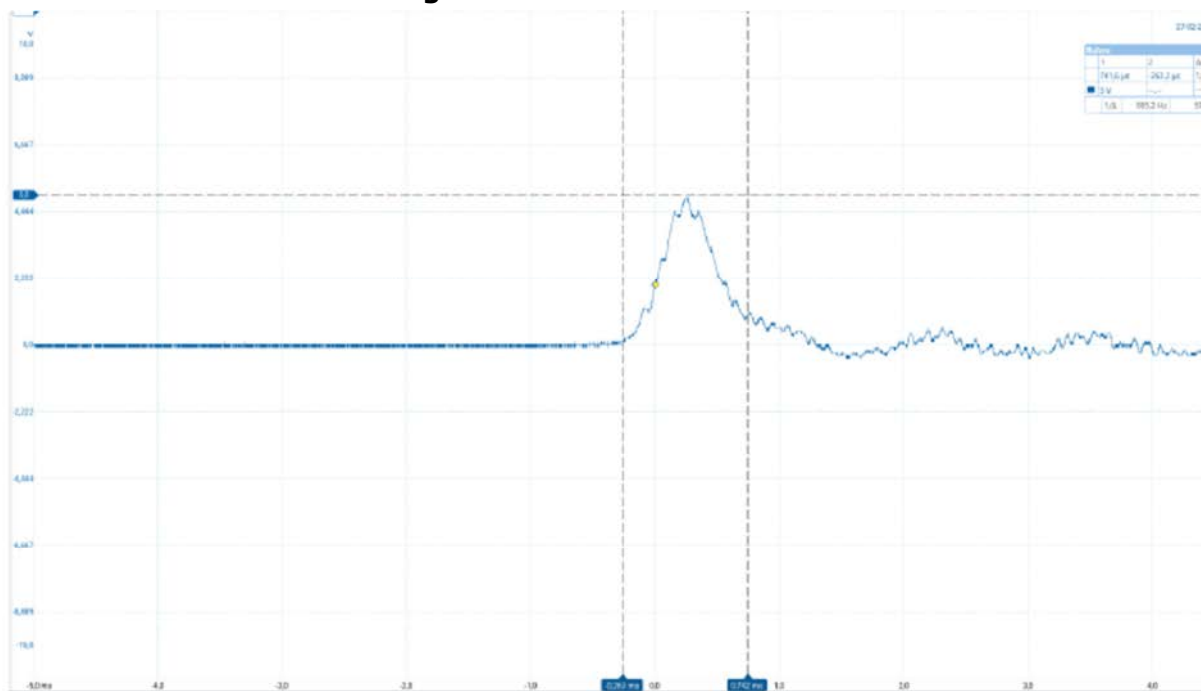

Curve 2 Positive shock e.g. Z-axis – Similar curves for alle other axes and directions. Dashed vertical lines indicate 1 ms. The dotted horizontal line indicates 500 g (1 V on the curve Y-axis corresponds to 100 g).

9.3 Moisture Test

Below is an extract from the picolog. Full data is available at Flux.

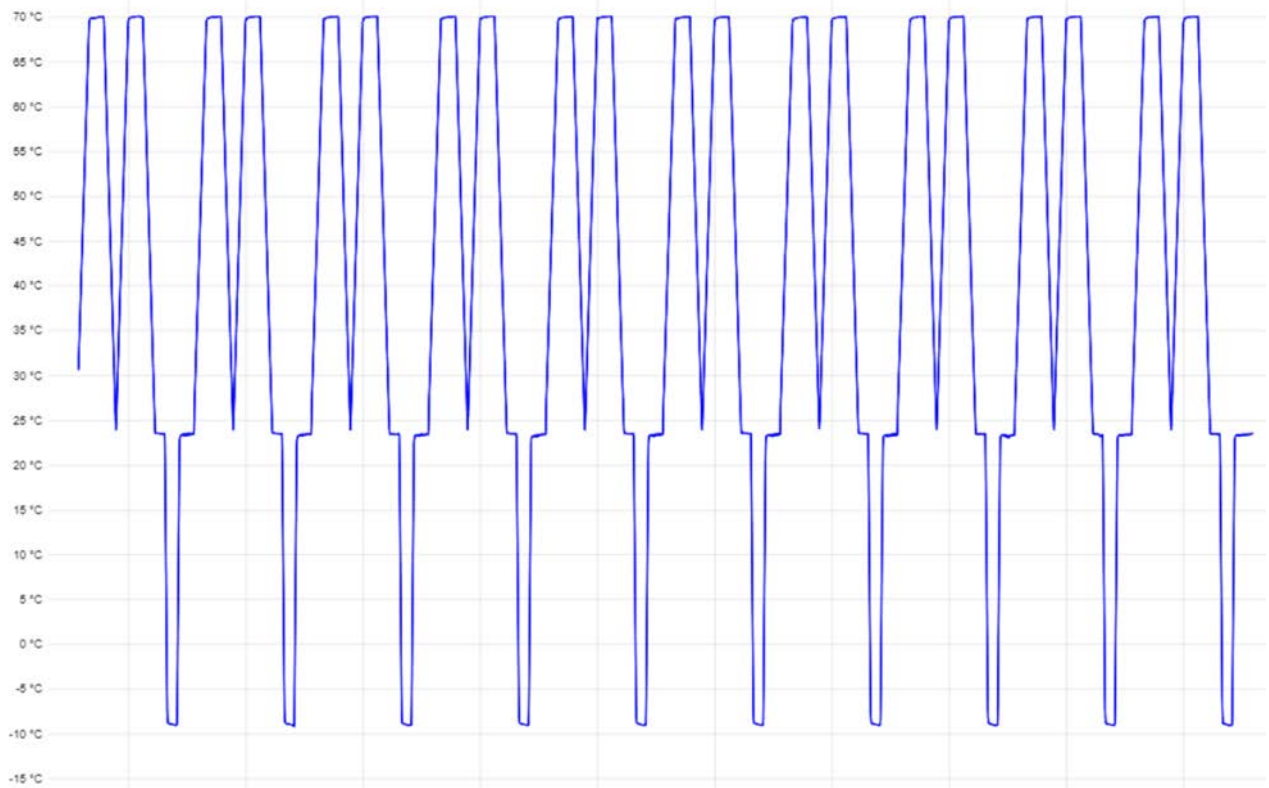

9.3.1 One cycle

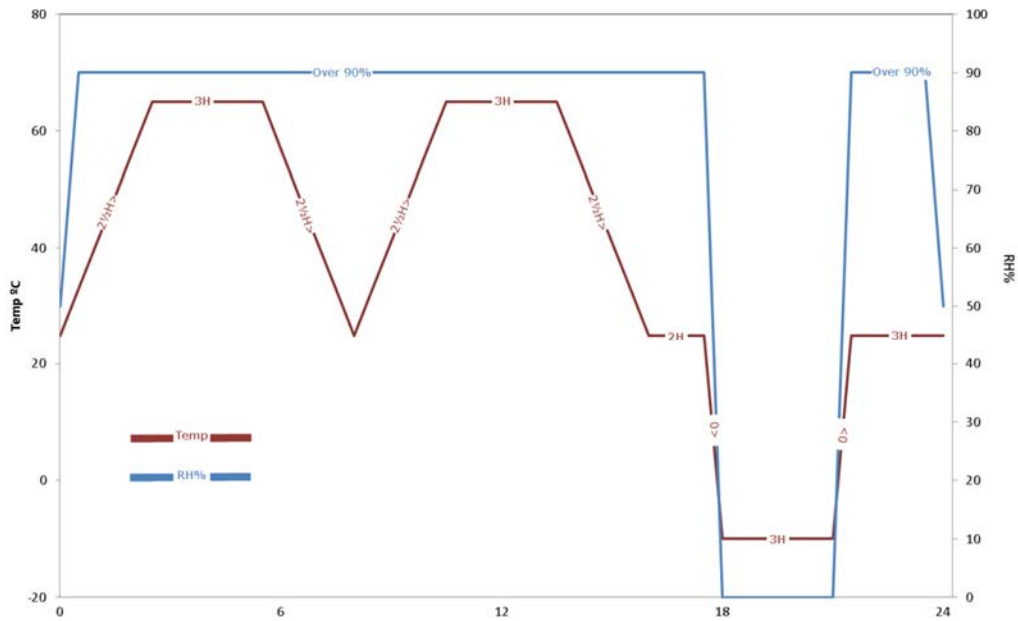

9.3.2 Full Test

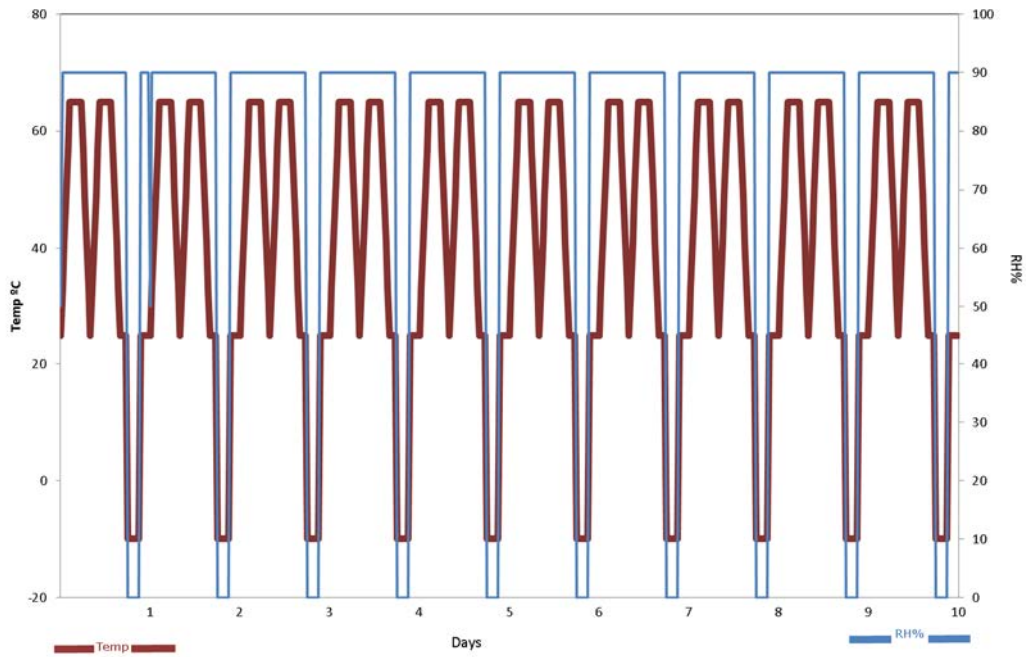

9.4 Operating life

Below is an example output of the operating life test performed at 85°C. Outputs for other tests are available at Flux.

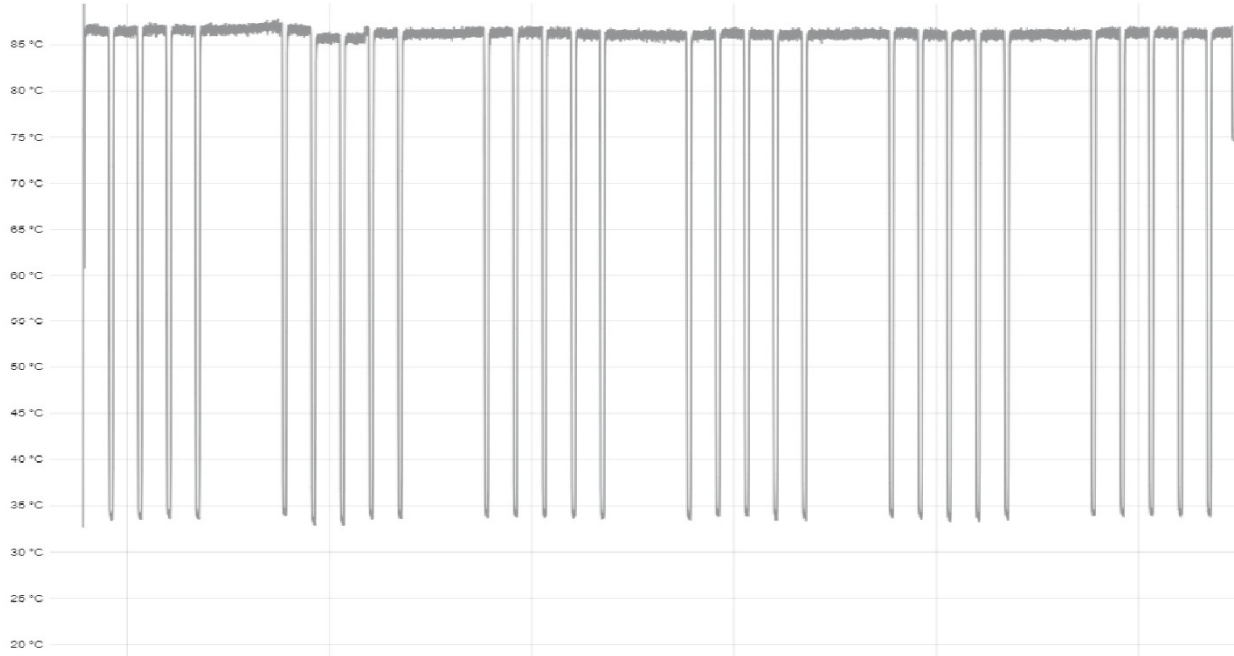

9.5 Overload

Below is an extract from the picolog. Full data is available at Flux.

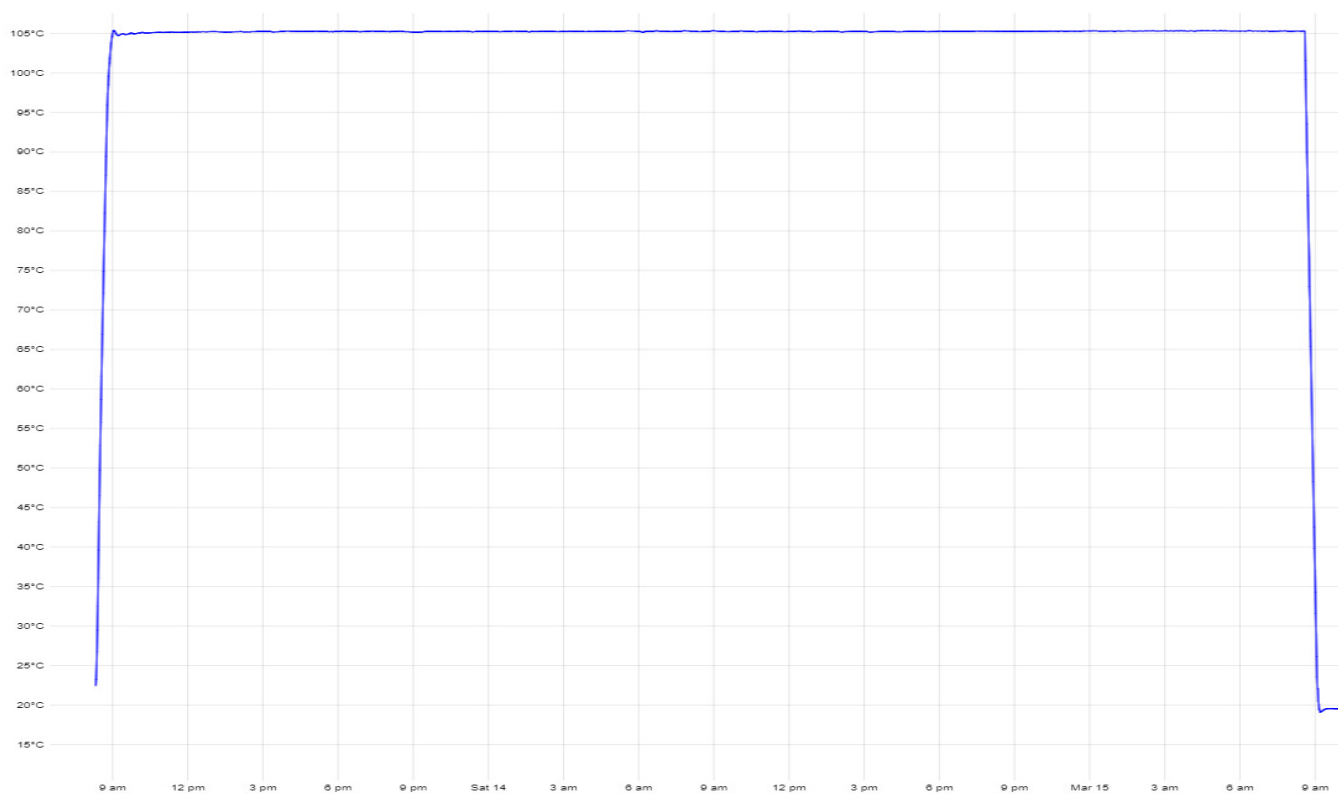

9.6 Partial discharge

Partial discharge was not applicable to any of the parts tested during this qualification campaign.

9.7 Thermal shock method

The total length of the test was 40800 seconds(6800 minutes), with the length of each cycle being approx. 4080 seconds(68 minutes). Plot 2 shows a close up of the final 2 cycles. The data is available at Flux in.plw format.

Plot1

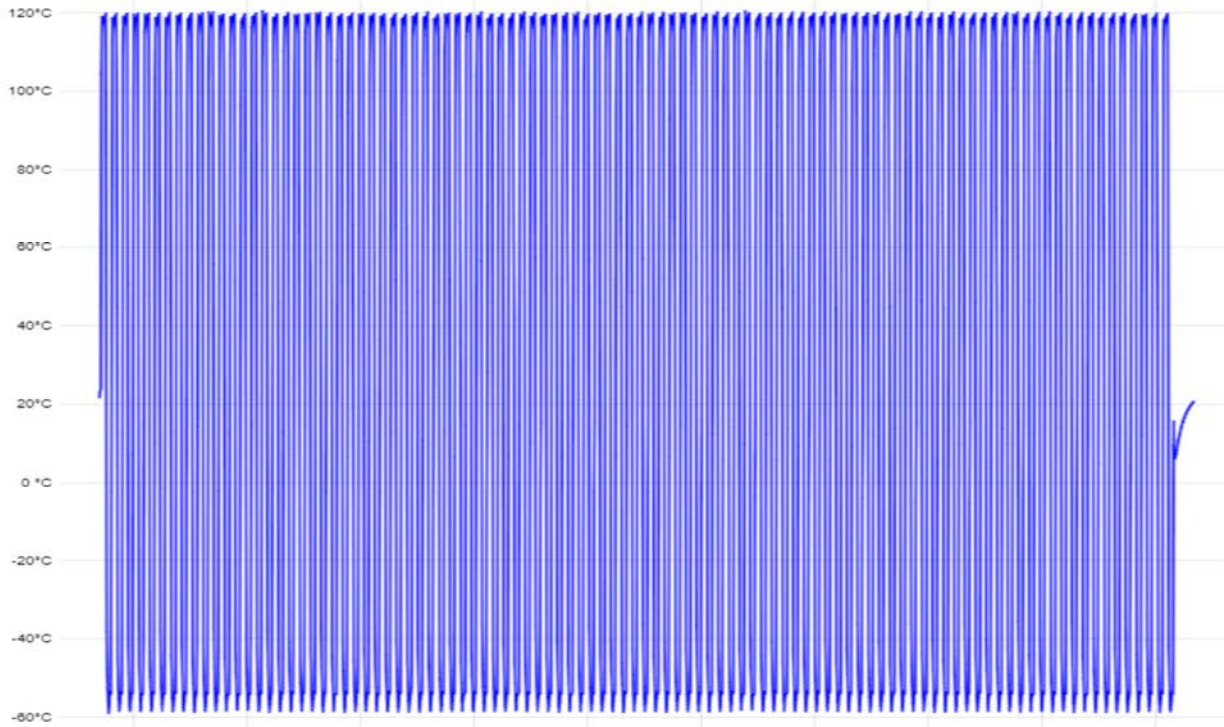

Plot 2

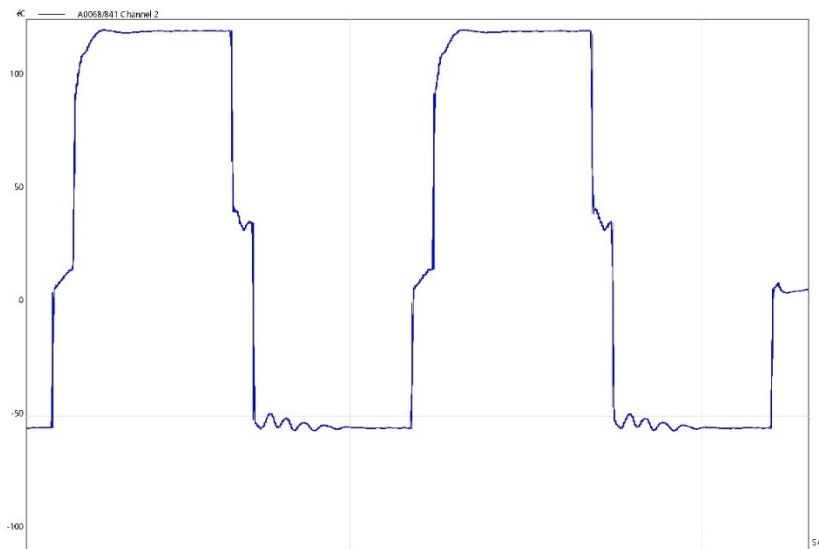

9.8 Internal Examination (DPA)

9.8.1 Q1 - ESCC320101301F12009014-1



Comments: None

9.8.2 Q2 - ESCC320101301F14790302-1 Pending

Comments:

9.8.3 Q3 - 14391017-1-B

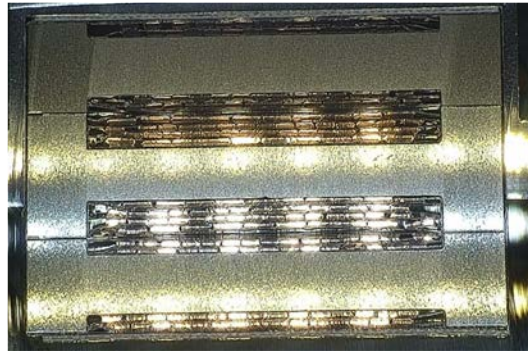

Comments: None

9.8.4 Q4 - 12000096-1-B



Comments: None

9.8.5 Q5 – ESCC320101301F14809024-1



Comments: None

9.8.6 Q6 – ESCC320101399F14229012-1

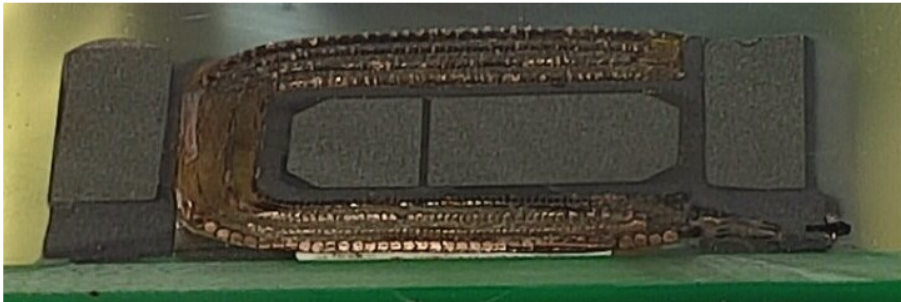

Comments: None.

9.8.7 Q7 – Not used

Comments: None

9.8.8 Q8 – ESCC320101301F14121040-1



Comments:

9.8.9 Q9 – ESCC320101301F12385000-1

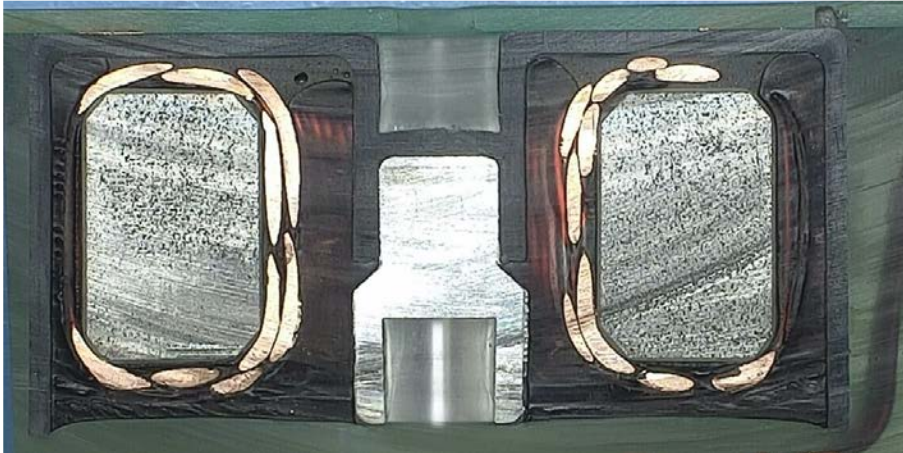

Comments: None

9.8.10 Q10 – ESCC320101301F14179033-1

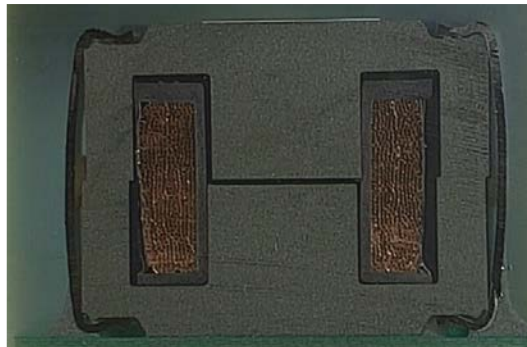

Comments: None

9.8.11 Q11 - 12251055-1-B

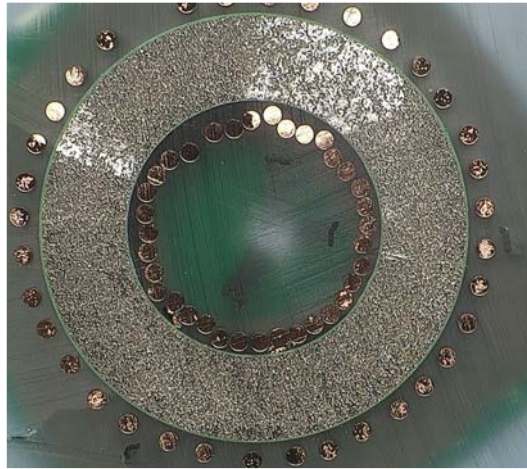

9.8.12 Q12 - 12141076-3-B



9.8.13 Q13 – 12311081-1-B



9.8.14 Q14 – 12011041-1-B



Comments: None

9.8.15Q15 – 14110319-1-B

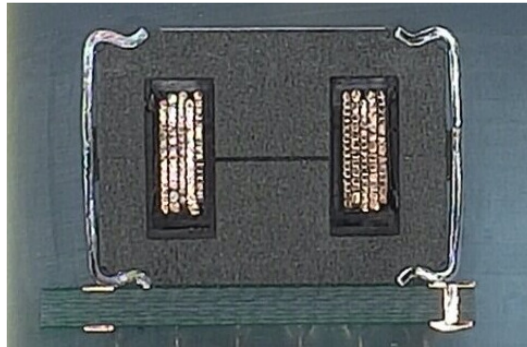

Comments: None

9.8.16Q16 – 14170338-2-B

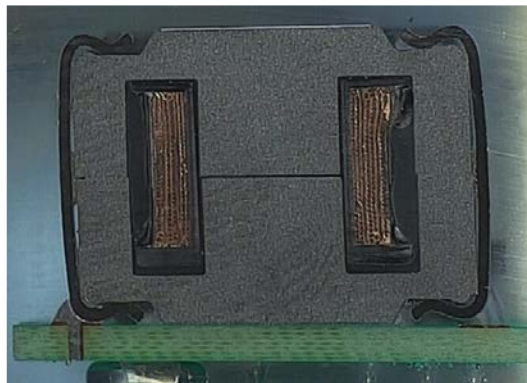

Comments: None

9.8.17 Q17 – 14220171-1-B

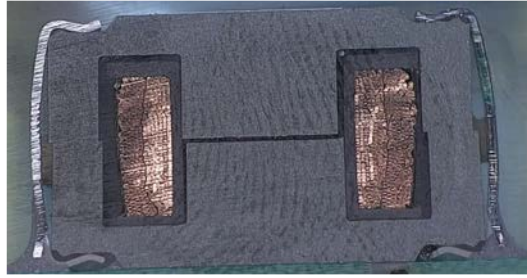

Comments: None

9.8.18 Q18 – ESCC320101301F12180007-2



Comments: None

9.8.19 Q19 – ESCC320101301F12011018-*

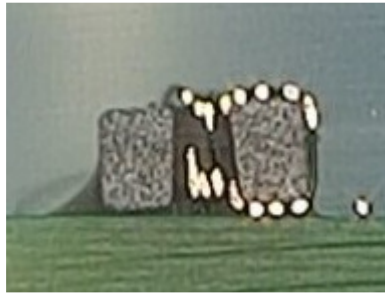

Comments: None

9.8.20 Q20 – ESCC320101301F14110308-1



Comments: None

9.8.21 Q21 – ESCC320101301F14230080-2 Pending

Comments: None

9.8.22 Q22 – 14890203-1-B



Comments: None

9.8.23 Q23 – 12248004-1-B



Comments: None

9.8.24 Q24 – 14241039-1-P

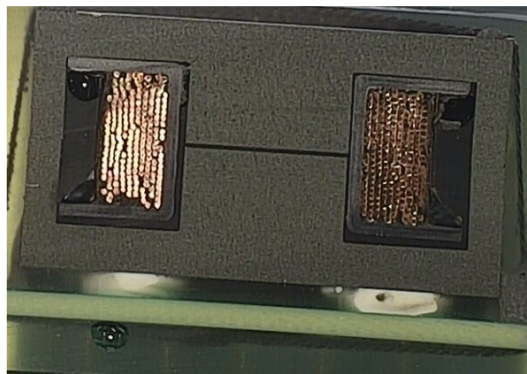

Comments: None

9.8.25 Q25 – 12411058-1-P

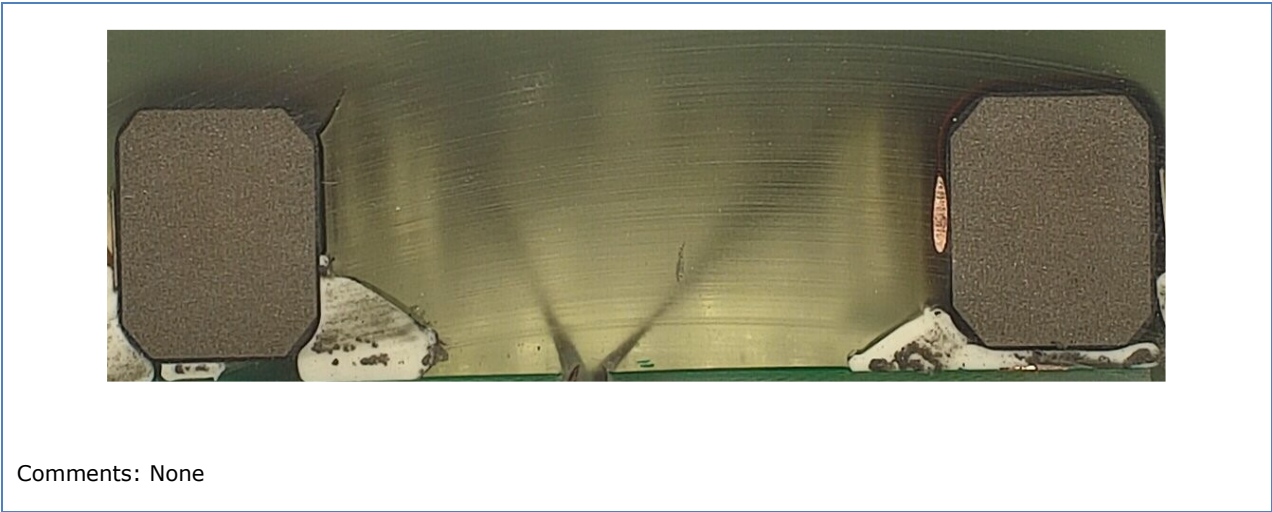

9.8.26 Q26 – 12411057-1-P

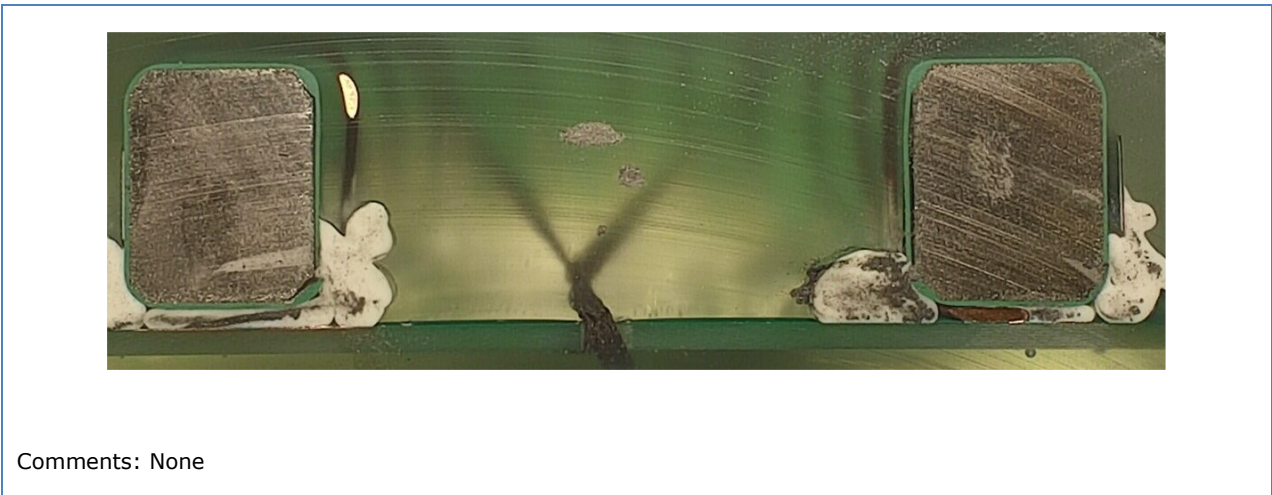

9.8.27 Q27 – 12141123-1-P

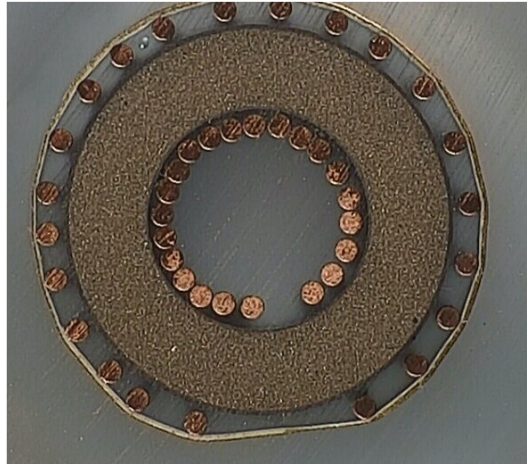

Comments: None

9.8.28 Q28 – 12011044-1-P

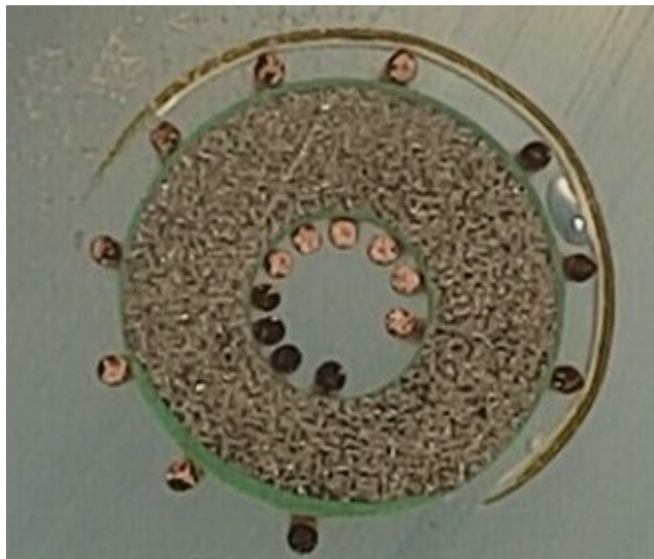

Comments: None

9.8.29 Q29 – ESCC320101301F12939014-1



Comments: None

9.8.30 Q30 – 19210136-1-B

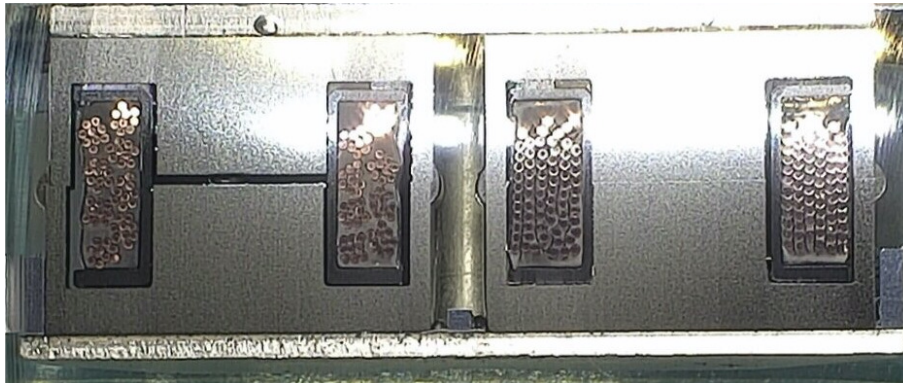

Comments: None

9.8.31 Q31 – 14110323-1-B Pending

Comments: None

9.8.32 Q332 – 14110323-1-B Pending

Comments: None

9.9 Observations and Observations on testing

- Manufacturing
 - Q18 was produced prior to the validation period and has been chosen as validation of the relief process.
 - Q30 contains 2 RM10 transformers in a shared housing.
- Testing
 - Q2 results are pending and will be included in next update.
 - Q4 the reference was not used.
 - Q21 results are pending and will be included in next update.
 - Q31 results are pending and will be included in next update.
 - Q32 results are pending and will be included in next update.
 - The electrical testing after life test were performed after 1000 hours. The results after 2000 hours will be included in the next update

9.10 Minor Nonconformances

None.

9.11 Critical Failures

None.

10. CONCLUSION

All units that have completed qualification are deemed to have passed as defined in FT 08690415^(RD8).

11. TEST DATA

11.1 Q01 - 12009014-1-C

TEST	Solderability	Terminal Strength	Visual Inspection	Electrical Characteristics		Insulation Resistance	Visual Inspection	Dielectric Withstanding Voltage	
				Inductance μH					Insul MOhm
CONDITIONS	§5.6	§5.8	§5.3	0,250V 100kHz		500V	§5.17	§5.3	§5.5 60s @ 500V
LIMITS				Max: 11.0	Max: 11.0				
				Min: 9.00	Min: 9.00				
S/N: 005	✓	✓	✓	9,43	10,03	✓	✓	✓	✓
S/N: 006	✓	✓	✓	9,46	9,61	✓	✓	✓	✓
S/N: 007	✓	✓	✓	10,21	10,06	✓	✓	✓	✓
S/N: 008	✓	✓	✓	10,28	10,43	✓	✓	✓	✓
S/N: 009	✓	✓	✓	10,13	10,21	✓	✓	✓	✓

TEST	Electrical Characteristics		Mounting on PCB	Visual Inspection	Electrical Characteristics		Life	Dielectric Withstanding Voltage	
	Inductance μH				Insul MOhm	Inductance μH			Insul MOhm
CONDITIONS	0,250V 100kHz		500V	§5.3	0,250V 100kHz		500V	§5.15	§5.5 5s @ 375V
LIMITS	Max: 11.0	Max: 11.0			Max: 11.0	Max: 11.0			
	Min: 9.00	Min: 9.00			Min: 5000	Min: 9.00			
S/N: 005	9,48	9,96	✓	✓	9,54	9,94	✓		
S/N: 006	9,44	9,68	✓	✓	9,51	9,69	✓		
S/N: 007	10,20	10,16	✓					✓	✓
S/N: 008	10,30	10,40	✓					✓	✓
S/N: 009	10,15	10,22	✓					✓	✓

Q01 – 12009014-1-C

TEST	Electrical Characteristics		Resistance to Solvents	Permanence of Marking	Vibration	Mechanical Shock	Visual Inspection	Electrical Characteristics		
	Inductance μ H	Insul MOhm						Inductance μ H	Insul MOhm	
CONDITIONS	0,250V 100kHz N1 N2		500V	§5.7	§5.9	§5.10	§5.11	§5.3	0,250V 100kHz N1 N2	500V
LIMITS	Max: 11.0	Max: 11.0							Max: 11.0	Max: 11.0
	Min: 9.00	Min: 9.00	Min: 5000						Min: 9.00	Min: 9.00
S/N: 005					✓	✓	✓	9,62	9,90	✓
S/N: 006					✓	✓	✓	9,50	9,80	✓
S/N: 007	10,11	10,22	✓	✓	✓					
S/N: 008	10,30	10,47	✓	✓	✓					
S/N: 009	10,31	10,08	✓	✓	✓					

TEST	Moisture Resistance	Electrical Characteristics		Winding Continuity	Thermal Shock	Electrical Characteristics		Partial Discharge	Temp Rise	
		Inductance μ H	Insul MOhm			Inductance μ H	Insul MOhm			
CONDITIONS	§5.12	0,250V 100kHz N1 N2		500V	RD6	§5.4	0,250V 100kHz N1 N2	500V	§5.16	§5.14
LIMITS		Max: 11.0	Max: 11.0				Max: 11.0	Max: 11.0		
		Min: 9.00	Min: 9.00	Min: 5000			Min: 9.00	Min: 9.00	Min: 5000	
S/N: 005	✓	9,64	9,92	✓	✓	✓	9,61	9,94	✓	
S/N: 006	✓	9,52	9,85	✓	✓	✓	9,48	9,83	✓	
S/N: 007										
S/N: 008										
S/N: 009										

Q01 – 12009014-1-C

TEST	Overload	Visual Inspection	Electrical Characteristics		DPA
			Inductance μ H		
CONDITIONS	§5.13	§5.3	0,250V 100kHz		500V
			N1	N2	
LIMITS			Max: 11.0	Max: 11.0	
			Min: 9.00	Min: 9.00	Min: 5000
S/N: 005	✓	✓	9,65	9,90	✓
S/N: 006	✓	✓	9,55	9,82	✓
S/N: 007					
S/N: 008					
S/N: 009					

11.2 Q2 - ESCC320101301F14790302-1 Pending

TEST	Solderability	Terminal Strength	Visual Inspection	Electrical Characteristics		Insulation Resistance	Visual Inspection	Dielectric Withstanding Voltage
				Inductance μ H	Insul MOhm			
CONDITIONS	§5.6	§5.8	§5.3	0,250V 100kHz N2	500V	§5.17	§5.3	§5.5 60s @ 300V
LIMITS				Max: 7239				
				Min: 4161	Min: 5000			
S/N: 006	✓	✓	✓	6936	✓			
S/N: 007	✓	✓	✓	6068	✓			
S/N: 008	✓	✓	✓	6941	✓			
S/N: 009	✓	✓	✓	6907	✓			
S/N: 010	✓	✓	✓	6716	✓			

TEST	Electrical Characteristics		Mounting on PCB	Visual Inspection	Electrical Characteristics		Life	Dielectric Withstanding Voltage
	Inductance μ H	Insul MOhm			Inductance μ H	Insul MOhm		
CONDITIONS	0,250V 100kHz N2	500V		§5.3	0,250V 100kHz N2	500V	§5.15	§5.5 5s @ 225V
LIMITS	Max: 7239				Max: 7239			
	Min: 4161	Min: 5000			Min: 4161	Min: 5000		
S/N: 006								
S/N: 007								
S/N: 008								
S/N: 009								
S/N: 010								

Q2 - ESCC320101301F14790302-1

TEST	Electrical Characteristics		Resistance to Solvents	Permanence of Marking	Vibration	Mechanical Shock	Visual Inspection	Electrical Characteristics	
	Inductance μ H	Insul MOhm						Inductance μ H	Insul MOhm
CONDITIONS	0,250V 100kHz N2	500V	§5.7	§5.9	§5.10	§5.11	§5.3	0,250V 100kHz N2	500V
LIMITS	Max: 7239							Max: 7239	
	Min: 4161	Min: 5000						Min: 4161	Min: 5000
S/N: 006									
S/N: 007									
S/N: 008									
S/N: 009									
S/N: 010									

TEST	Moisture Resistance	Electrical Characteristics		Winding Continuity	Thermal Shock	Electrical Characteristics		Partial Discharge	Temp Rise
		Inductance μ H	Insul MOhm			Inductance μ H	Insul MOhm		
CONDITIONS	§5.12	0,250V 100kHz N2	500V	RD6	§5.4	0,250V 100kHz N2	500V	§5.16	§5.14
LIMITS		Max: 7239				Max: 7239			
		Min: 4161	Min: 5000			Min: 4161	Min: 5000		
S/N: 006									
S/N: 007									
S/N: 008									
S/N: 009									
S/N: 010									

Q2 - ESCC320101301F14790302-1

TEST	Overload	Visual Inspection	Electrical Characteristics		DPA
			Inductance μ H	Insul MOhm	
CONDITIONS	§5.13	§5.3	0,250V 100kHz N2		§5.18
LIMITS			Max:	7239	
			Min:	4161	Min: 5000
S/N: 006					
S/N: 007					
S/N: 008					
S/N: 009					
S/N: 010					

11.3 Q3 – 14391017-1-B

TEST	Solderability	Terminal Strength	Visual Inspection	Electrical Characteristics			Insulation Resistance	Visual Inspection	Dielectric Withstanding Voltage	
				Inductance μ H		Insul MOhm				
CONDITIONS	§5.6	§5.8	§5.3	300mV 100kHz			500V	§5.17	§5.3	§5.5 60s @ 500V
LIMITS				N1(A4-A3)	N7(B4-B3)	N1(C4-C3)				
				Max: 100,7	Max: 194,7	Max: 100,7				
				Min: 91,1	Min: 166,8	Min: 91,1	Min: 5000			
S/N: 026	✓		✓	96,3	179,9	96,7	✓	✓	✓	✓
S/N: 027	✓		✓	96,5	179,7	96,5	✓	✓	✓	✓
S/N: 028	✓		✓	96,2	179,4	96,3	✓	✓	✓	✓
S/N: 029	✓		✓	95,8	179,5	96,9	✓	✓	✓	✓
S/N: 030	✓		✓	96,3	179,2	96,3	✓	✓	✓	✓

TEST	Electrical Characteristics				Mounting on PCB	Visual Inspection	Electrical Characteristics				Life	Dielectric Withstanding Voltage
	Inductance μ H			Insul MOhm			Inductance μ H			Insul MOhm		
CONDITIONS	300mV 100kHz			500V		§5.3	300mV 100kHz			500V	§5.15	§5.5 5s @ 375V
LIMITS	N1(A4-A3)	N7(B4-B3)	N1(C4-C3)				N1(A4-A3)	N7(B4-B3)	N1(C4-C3)			
	Max: 100,7	Max: 194,7	Max: 100,7				Max: 100,7	Max: 194,7	Max: 100,7			
	Min: 91,1	Min: 166,8	Min: 91,1	Min: 5000			Min: 91,1	Min: 166,8	Min: 91,1	Min: 5000		
S/N: 026	96,2	178,9	96,5	✓	✓	✓	96,7	180,1	96,3	✓		
S/N: 027	96,4	179,3	96,3	✓	✓	✓	96,6	178,2	96,2	✓		
S/N: 028	96,5	181,3	96,7	✓							✓	✓
S/N: 029	95,7	180,2	97,0	✓							✓	✓
S/N: 030	96,2	178,3	96,4	✓							✓	✓

Q3 – 14391017-1-B

TEST	Electrical Characteristics			Resistance to Solvents	Permanence of Marking	Vibration	Mechanical Shock	Visual Inspection	Electrical Characteristics			
	Inductance μ H		Insul MOhm						Inductance μ H		Insul MOhm	
CONDITIONS	300mV 100kHz			500V	§5.7	§5.9	§5.10	§5.11	§5.3	300mV 100kHz		
	N1(A4-A3)	N7(B4-B3)	N1(C4-C3)							N1(A4-A3)	N7(B4-B3)	N1(C4-C3)
LIMITS	Max: 100,7	Max: 194,7	Max: 100,7							Max: 100,7	Max: 194,7	Max: 100,7
	Min: 91,1	Min: 166,8	Min: 91,1	Min: 5000						Min: 91,1	Min: 166,8	Min: 91,1
S/N: 026							✓	✓	✓	96,6	181,1	96,3
S/N: 027							✓	✓	✓	96,6	179,2	96,2
S/N: 028	96,4	181,2	96,6	✓	✓	✓						
S/N: 029	95,3	180,1	96,0	✓	✓	✓						
S/N: 030	96,3	178,9	96,5	✓	✓	✓						

TEST	Moisture Resistance	Electrical Characteristics			Winding Continuity	Thermal Shock	Electrical Characteristics			Partial Discharge		
		Inductance μ H		Insul MOhm			Inductance μ H		Insul MOhm			
CONDITIONS	§5.12	300mV 100kHz			500V	RD6	§5.4	300mV 100kHz			500V	§5.16
		N1(A4-A3)	N7(B4-B3)	N1(C4-C3)				N1(A4-A3)	N7(B4-B3)	N1(C4-C3)		
LIMITS		Max: 100,7	Max: 194,7	Max: 100,7				Max: 100,7	Max: 194,7	Max: 100,7		
		Min: 91,1	Min: 166,8	Min: 91,1	Min: 5000			Min: 91,1	Min: 166,8	Min: 91,1	Min: 5000	
S/N: 026	✓	96,8	180,2	96,1	✓	✓	✓	96,7	180,3	96,3	✓	
S/N: 027	✓	96,5	178,3	96,1	✓	✓	✓	96,9	179,1	96,7	✓	
S/N: 028												
S/N: 029												
S/N: 030												

Q3 – 14391017-1-B

TEST	Temp Rise	Overload	Visual Inspection	Electrical Characteristics			DPA	
				Inductance μ H		Insul MOhm		
CONDITIONS	§5.14	§5.13	§5.3	300mV 100kHz			500V	§5.18
LIMITS				N1(A4-A3)	N7(B4-B3)	N1(C4-C3)		
				Max: 100,7	Max: 194,7	Max: 100,7		
				Min: 91,1	Min: 166,8	Min: 91,1	Min: 5000	
S/N: 026		✓	✓	96,4	181,3	96,2	✓	✓
S/N: 027		✓	✓	96,8	180,1	96,6	✓	
S/N: 028								
S/N: 029								
S/N: 030								

11.4 Q4 – 12000096-1-B

TEST	Solderability	Terminal Strength	Visual Inspection	Electrical Characteristics		Insulation Resistance	Visual Inspection	Dielectric Withstanding Voltage
					Saturation Time μ s			
CONDITIONS	§5.6	§5.8	§5.3		V _{peak} = 1.0V	§5.17	§5.3	§5.5 60s @ 500V
LIMITS					Max:	1,4		
					Min:	0,9		
S/N: 00A					1,08		✓	
S/N: 00B					1,13		✓	
S/N: 00C					1,14		✓	
S/N: 00D					1,17		✓	
S/N: 00E					1,17		✓	

TEST	Electrical Characteristics		Mounting on PCB	Visual Inspection	Electrical Characteristics		Life	Dielectric Withstanding Voltage
		Saturation Time μ s				Saturation Time μ s		
CONDITIONS		V _{peak} = 1.0V		§5.3		V _{peak} = 1.0V	§5.15	§5.5 5s @ 375V
LIMITS		Max:	1,4			Max:	1,4	
		Min:	0,9			Min:	0,9	
S/N: 00A		1,08	✓	✓		1,13		
S/N: 00B		1,13	✓	✓		1,16		
S/N: 00C		1,14					✓	
S/N: 00D		1,17					✓	
S/N: 00E		1,17					✓	

Q4 – 1200096-1-B

TEST	Electrical Characteristics		Resistance to Solvents	Permanence of Marking	Vibration	Mechanical Shock	Visual Inspection	Electrical Characteristics	
		Saturation Time μ S							Saturation Time μ S
CONDITIONS		Vpeak =1.0V	§5.7	§5.9	§5.10	§5.11	§5.3		Vpeak =1.0V
LIMITS		Max: 1,4							Max: 1,4
		Min: 0,9							Min: 0,9
S/N: 00A					✓	✓	✓		1,04
S/N: 00B					✓	✓	✓		1,06
S/N: 00C		1,12	N/A	N/A					
S/N: 00D		1,17	N/A	N/A					
S/N: 00E		1,13	N/A	N/A					

TEST	Moisture Resistance	Electrical Characteristics		Winding Continuity	Thermal Shock	Electrical Characteristics		Partial Discharge	Temp Rise
			Saturation Time μ S				Saturation Time μ S		
CONDITIONS	§5.12		Vpeak =1.0V	RD6	§5.4		Vpeak =1.0V	§5.16	§5.14
LIMITS			Max: 1,4				Max: 1,4		
			Min: 0,9				Min: 0,9		
S/N: 00A	✓		1,08		✓		0,99		
S/N: 00B	✓		1,01		✓		1,02		
S/N: 00C									
S/N: 00D									
S/N: 00E									

Q4 – 1200096-1-B

TEST	Overload	Visual Inspection	Electrical Characteristics		DPA
				Saturation Time µs	
CONDITIONS	§5.13	§5.3		V _{peak} = 1.0V	§5.18
LIMITS				Max: 1,4	
				Min: 0,9	
S/N: 00A		✓		0,98	✓
S/N: 00B		✓		0,99	
S/N: 00C					
S/N: 00D					
S/N: 00E					

11.5 Q5 – 14809024-1-C

TEST	Solderability	Terminal Strength	Visual Inspection	Electrical Characteristics		Insulation Resistance	Visual Inspection	Dielectric Withstanding Voltage	
				Inductance μH	Insul MOhm				
CONDITIONS	§5.6	§5.8	§5.3	0,050V 300kHz N1 N2		500V	§5.17	§5.3	§5.5 60s @ 300V
LIMITS				Max: 0,0488	Max: 0,0488				
				Min: 0,0424	Min: 0,0424				
S/N: 00A	✓		✓	Pass	Pass	✓	✓	✓	
S/N: 00B	✓		✓	Pass	Pass	✓	✓	✓	
S/N: 00C	✓		✓	Pass	Pass	✓	✓	✓	
S/N: 00D	✓		✓	Pass	Pass	✓	✓	✓	
S/N: 00E	✓		✓	Pass	Pass	✓	✓	✓	

TEST	Electrical Characteristics		Mounting on PCB	Visual Inspection	Electrical Characteristics		Life	Dielectric Withstanding Voltage	
	Inductance μH	Insul MOhm			Inductance μH	Insul MOhm			
CONDITIONS	0,050V 300kHz		500V	§5.3	0,050V 300kHz		500V	§5.15	§5.5 5s @ 225V
LIMITS	Max: 0,0488	Max: 0,0488			Max: 0,0488	Max: 0,0488			
	Min: 0,0424	Min: 0,0424			Min: 5000	Min: 0,0424			
S/N: 00A	Pass	Pass	✓	✓	✓	Pass	Pass	✓	
S/N: 00B	Pass	Pass	✓	✓	✓	Pass	Pass	✓	
S/N: 00C	Pass	Pass	✓					✓	✓
S/N: 00D	Pass	Pass	✓					✓	✓
S/N: 00E	Pass	Pass	✓					✓	✓

Q5 – 14809024-1-C

TEST	Electrical Characteristics		Resistance to Solvents	Permanence of Marking	Vibration	Mechanical Shock	Visual Inspection	Electrical Characteristics		
	Inductance μ H	Insul MOhm						Inductance μ H	Insul MOhm	
CONDITIONS	0,050V 300kHz		500V	§5.7	§5.9	§5.10	§5.11	§5.3	0,050V 300kHz	500V
LIMITS	Max: 0,0488	Max: 0,0488							Max: 0,0488	Max: 0,0488
	Min: 0,0424	Min: 0,0424	Min: 5000						Min: 0,0424	Min: 0,0424
S/N: 00A					✓	✓	✓	Pass	Pass	✓
S/N: 00B					✓	✓	✓	Pass	Pass	✓
S/N: 00C	Pass	Pass	✓	N/A	N/A					
S/N: 00D	Pass	Pass	✓	N/A	N/A					
S/N: 00E	Pass	Pass	✓	N/A	N/A					

TEST	Moisture Resistance	Electrical Characteristics		Winding Continuity	Thermal Shock	Electrical Characteristics		Partial Discharge	Temp Rise	
		Inductance μ H	Insul MOhm			Inductance μ H	Insul MOhm			
CONDITIONS	§5.12	0,050V 300kHz		500V	RD6	§5.4	0,050V 300kHz	500V	§5.16	§5.14
LIMITS		Max: 0,0488	Max: 0,0488				Max: 0,0488	Max: 0,0488		
		Min: 0,0424	Min: 0,0424	Min: 5000			Min: 0,0424	Min: 0,0424	Min: 5000	
S/N: 00A	✓	Pass	Pass	✓	✓	✓	Pass	Pass	✓	
S/N: 00B	✓	Pass	Pass	✓	✓	✓	Pass	Pass	✓	
S/N: 00C										
S/N: 00D										
S/N: 00E										

Q5 – 14809024-1-C

TEST	Overload	Visual Inspection	Electrical Characteristics		DPA
			Inductance μ H	Insul MOhm	
CONDITIONS	§5.13	§5.3	0,050V 300kHz		500V §5.18
LIMITS			Max: 0,0488	Max: 0,0488	
			Min: 0,0424	Min: 0,0424	Min: 5000
S/N: 00A	✓	✓	Pass	Pass	✓
S/N: 00B	✓	✓	Pass	Pass	✓
S/N: 00C					
S/N: 00D					
S/N: 00E					

11.6 Q06 – 14229012-1-C

TEST	Solderability	Terminal Strength	Visual Inspection	Electrical Characteristics						Insulation Resistance	
				Inductance μ H					Insul MOhm		
CONDITIONS	§5.6	§5.8	§5.3	0,250V 100kHz						500V	§5.17
LIMITS				N1A	N1B	N1C	N1D	N2			
				Max: 12,10	Max: 12,10	Max: 12,10	Max: 12,10	Max: 4838			
				Min: 10,94	Min: 10,94	Min: 10,94	Min: 10,94	Min: 4378	Min: 5000		
S/N: 010	✓	✓	✓	11,9	11,9	11,9	11,91	4520	✓	✓	
S/N: 011	✓	✓	✓	11,67	11,67	11,67	11,68	4435	✓	✓	
S/N: 012	✓	✓	✓	11,9	11,89	11,9	11,9	4515	✓	✓	
S/N: 013	✓	✓	✓	11,82	11,8	11,8	11,81	4488	✓	✓	
S/N: 014	✓	✓	✓	11,83	11,81	11,81	11,82	4490	✓	✓	

TEST	Visual Inspection	Dielectric Withstanding Voltage	Electrical Characteristics						Mounting on PCB	Visual Inspection
			Inductance μ H					Insul MOhm		
CONDITIONS	§5.3	§5.5 60s @ 500V	0,250V 100kHz						500V	
LIMITS			N1A	N1B	N1C	N1D	N2			
			Max: 12,10	Max: 12,10	Max: 12,10	Max: 12,10	Max: 4838			
			Min: 10,94	Min: 10,94	Min: 10,94	Min: 10,94	Min: 4378	Min: 5000		
S/N: 010	✓	✓	11,89	11,88	11,87	11,87	4515	✓	✓	
S/N: 011	✓	✓	11,67	11,66	11,65	11,64	4434	✓	✓	
S/N: 012	✓	✓	11,9	11,9	11,9	11,9	4510	✓	✓	
S/N: 013	✓	✓	11,8	11,8	11,8	11,8	4492	✓	✓	
S/N: 014	✓	✓	11,8	11,8	11,8	11,8	4487	✓	✓	

Q06 – 14229012-1-C

TEST	Electrical Characteristics										Life Test	Dielectric Withstanding Voltage	Electrical Characteristics										
	Inductance μ H												Insul MOhm	Inductance μ H									
CONDITIONS	0,250V 100kHz										500V	§5.15		0,250V 100kHz									
	N1A		N1B		N1C		N1D		N2				N1A		N1B		N1C		N1D		N2		
LIMITS	Max:	12,10	Max:	12,10	Max:	12,10	Max:	12,10	Max:	4838			Max:	12,10	Max:	12,10	Max:	12,10	Max:	12,10	Max:	4838	
	Min:	10,94	Min:	10,94	Min:	10,94	Min:	10,94	Min:	4378	Min:	5000			Min:	10,94	Min:	10,94	Min:	10,94	Min:	10,94	Min:
S/N: 010	11,89	11,88	11,87	11,87	4522	✓																	
S/N: 011	11,67	11,66	11,65	11,64	4450	✓																	
S/N: 012	11,9	11,9	11,9	11,9	4528	✓	✓				✓	✓											
S/N: 013	11,8	11,8	11,8	11,8	4498	✓	✓				✓	✓											
S/N: 014	11,8	11,8	11,8	11,8	4497	✓	✓				✓	✓											

TEST	Electrical Characteristics	Resistance to Solvents	Permanence of Marking	Vibration	Mechanical Shock	Visual Inspection
	Insul MOhm					
CONDITIONS	500V	§5.7	§5.9	§5.10	§5.11	§5.3
LIMITS						
	Min:	5000				
S/N: 010				✓	✓	✓
S/N: 011				✓	✓	✓
S/N: 012	✓	✓	✓			
S/N: 013	✓	✓	✓			
S/N: 014	✓	✓	✓			

Q06 – 14229012-1-C

TEST	Electrical Characteristics								Moisture Resistance	Electrical Characteristics									
	Inductance μ H									Insul MOhm	Inductance μ H								Insul MOhm
CONDITIONS	0,250V 100kHz								500V	§5.12	0,250V 100kHz								500V
LIMITS	N1A	N1B	N1C	N1D	N2				N1A		N1B	N1C	N1D	N2					
	Max: 12,10	Max: 12,10	Max: 12,10	Max: 12,10	Max: 4838				Max: 12,10	Max: 12,10	Max: 12,10	Max: 12,10	Max: 4838						
	Min: 10,94	Min: 10,94	Min: 10,94	Min: 10,94	Min: 4378				Min: 10,94	Min: 10,94	Min: 10,94	Min: 10,94	Min: 4378						
S/N: 010	11,92	11,78	11,84	11,88	4540	✓			✓		11,58	11,89	11,97	4545	✓				
S/N: 011	11,68	11,66	11,72	11,63	4459	✓			✓	11,80	11,72	11,68	11,64	4454	✓				
S/N: 012																			
S/N: 013																			
S/N: 014																			

TEST	Winding Continuity	Thermal Shock	Electrical Characteristics							Overload	Visual Inspection	
			Inductance μ H									Insul MOhm
CONDITIONS	RD6	§5.4	0,250V 100kHz							500V	§5.13	§5.3
LIMITS			N1A	N1B	N1C	N1D	N2					
	Max: 12,10	Max: 12,10	Max: 12,10	Max: 12,10	Max: 4838							
	Min: 10,94	Min: 10,94	Min: 10,94	Min: 10,94	Min: 4378							
S/N: 010	✓	✓	11,88	11,85	11,92	11,82	4512	✓	✓	✓		
S/N: 011	✓	✓	11,69	11,62	11,45	11,63	4430	✓	✓	✓		
S/N: 012												
S/N: 013												
S/N: 014												

Q06 – 14229012-1-C

TEST	Electrical Characteristics								DPA	
	Inductance μ H						Insul MOhm			
CONDITIONS	0,250V 100kHz						500V		§5.18	
	N1A		N1B		N1C		N1D		N2	
LIMITS	Max:	12,10	Max:	12,10	Max:	12,10	Max:	12,10	Max:	4838
	Min:	10,94	Min:	10,94	Min:	10,94	Min:	10,94	Min:	4378
									Min:	5000
S/N: 010	11,80		11,79		11,82		11,8		4544	✓
S/N: 011	11,70		11,68		11,55		11,61		4447	✓
S/N: 012										
S/N: 013										
S/N: 014										

11.7 Q07 – Not used

TEST	Solderability	Terminal Strength	Visual Inspection	Electrical Characteristics										Insulation Resistance	
				Inductance μH											Insul MOhm
CONDITIONS	§5.6	§5.8	§5.3	0,250V 100kHz										500V	§5.17
				N1A	N1B	N2	N3	N4	N5						
LIMITS				Max: 475	Max: 475	Max: 4277	Max: 4277	Max: 4277	Max: 4277	Max: 4277	Max: 4277	Min: 5000			
				Min: 281	Min: 281	Min: 2527	Min: 2527	Min: 2527	Min: 2527	Min: 2527	Min: 2527				
S/N:															
S/N:															
S/N:															
S/N:															
S/N:															

TEST	Visual Inspection	Dielectric Withstanding Voltage	Electrical Characteristics										Mounting on PCB	Visual Inspection	
			Inductance μH												Insul MOhm
CONDITIONS	§5.3	§5.5 60s @ 500V	0,250V 100kHz										500V		
			N1A	N1B	N2	N3	N4	N5							
LIMITS			Max: 475	Max: 475	Max: 4277	Max: 4277	Max: 4277	Max: 4277	Max: 4277	Max: 4277	Max: 4277	Min: 5000			
			Min: 281	Min: 281	Min: 2527	Min: 2527	Min: 2527	Min: 2527	Min: 2527	Min: 2527	Min: 2527				
S/N:															
S/N:															
S/N:															
S/N:															
S/N:															

Q07 – Not Used

TEST	Electrical Characteristics										Mounting on PCB	Visual Inspection
	Inductance μ H											
CONDITIONS	0,250V 100kHz										500V	§5.3
LIMITS	Max:	475	Max:	475	Max:	4277	Max:	4277	Max:	4277	Min: 5000	
	Min:	281	Min:	281	Min:	2527	Min:	2527	Min:	2527		
S/N:												
S/N:												
S/N:												
S/N:												
S/N:												

TEST	Electrical Characteristics										Life Test	Dielectric Withstanding Voltage	Electrical Characteristics												
	Inductance μ H												Insul MOhm	Inductance μ H											
CONDITIONS	0,250V 100kHz										500V	§5.15	§5.5 5s @ 375V	0,250V 100kHz											
LIMITS	Max:	475	Max:	475	Max:	4277	Max:	4277	Max:	4277	Min: 5000			Max:	475	Max:	475	Max:	4277	Max:	4277	Max:	4277	Max:	4277
	Min:	281	Min:	281	Min:	2527	Min:	2527	Min:	2527				Min:	281	Min:	281	Min:	2527	Min:	2527	Min:	2527	Min:	2527
S/N:																									
S/N:																									
S/N:											✓														
S/N:											✓														
S/N:											✓														

Q07 – Not Used

TEST	Electrical Characteristics	Resistance to Solvents	Permanence of Marking	Vibration	Mechanical Shock	Visual Inspection
	Insul MOhm					
CONDITIONS	500V	§5.7	§5.9	§5.10	§5.11	§5.3
LIMITS						
	Min: 5000					
S/N:						
S/N:						
S/N:						
S/N:						
S/N:						

TEST	Electrical Characteristics										Moisture Resistance	Electrical Characteristics											
	Inductance µH											Insul MOhm	Inductance µH										Insul MOhm
CONDITIONS	0,250V 100kHz										500V	§5.12	0,250V 100kHz										500V
LIMITS	N1A	N1B	N2	N3	N4	N5						N1A	N1B	N2	N3	N4	N5						
	Max: 475	Max: 475	Max: 4277	Max: 4277	Max: 4277	Max: 4277						Max: 475	Max: 475	Max: 4277	Max: 4277	Max: 4277	Max: 4277						
	Min: 281	Min: 281	Min: 2527	Min: 2527	Min: 2527	Min: 2527					Min: 5000		Min: 281	Min: 281	Min: 2527	Min: 2527	Min: 2527	Min: 2527					Min: 5000
S/N:																							
S/N:																							
S/N:																							
S/N:																							
S/N:																							

Q07 – Not Used

TEST	Winding Continuity	Thermal Shock	Electrical Characteristics								Partial Discharge	Overload	Visual Inspection	
			Inductance μ H											Insul MOhm
CONDITIONS	RD6	§5.4	0,250V 100kHz								500V	§5.16	§5.13	§5.3
LIMITS			N1A	N1B	N2	N3	N4	N5						
			Max: 475	Max: 475	Max: 4277	Max: 4277	Max: 4277	Max: 4277	Min: 5000					
S/N:			Min: 281	Min: 281	Min: 2527	Min: 2527	Min: 2527	Min: 2527						
S/N:														
S/N:														
S/N:														
S/N:														

TEST	Electrical Characteristics								DPA	
	Inductance μ H									Insul MOhm
CONDITIONS	0,250V 100kHz								500V	§5.18
LIMITS	N1A	N1B	N2	N3	N4	N5				
	Max: 475	Max: 475	Max: 4277	Max: 4277	Max: 4277	Max: 4277	Min: 5000			
S/N:	Min: 281	Min: 281	Min: 2527	Min: 2527	Min: 2527	Min: 2527				
S/N:										
S/N:										
S/N:										
S/N:										

11.8 Q08 – 14121040-1-C

TEST	Solderability	Terminal Strength	Visual Inspection	Electrical Characteristics						Insulation Resistance			
				Inductance μ H							Insul MOhm		
CONDITIONS	§5.6	§5.8	§5.3	0,100V 300kHz						500V	§5.17		
LIMITS				N1		N2		N3		N4			
				Max:	21,26	Max:	59,1	Max:	2,55	Max:	2,55		Min: 5000
				Min:	19,24	Min:	53,4	Min:	2,14	Min:	2,14		
S/N: 004	N/A	N/A	N/A	20,8		58,9		2,48		2,46		✓	✓
S/N: 006	N/A	N/A	N/A	20,69		55,2		2,46		2,45		✓	✓
S/N: 007	N/A	N/A	N/A	19,8		55,1		2,37		2,33		✓	✓
S/N: 008	N/A	N/A	N/A	19,99		55,7		2,36		2,35		✓	✓
S/N: 009	N/A	N/A	N/A	19,9		55,4		2,41		2,35		✓	✓

TEST	Visual Inspection	Dielectric Withstanding Voltage	Electrical Characteristics						Mounting on PCB	Visual Inspection		
			Inductance μ H								Insul MOhm	
CONDITIONS	§5.3	§5.5 60s @ 500V	0,100V 300kHz						500V			
LIMITS			N1		N2		N3		N4			
			Max:	21,26	Max:	59,1	Max:	2,55	Max:	2,55		Min: 5000
			Min:	19,24	Min:	53,4	Min:	2,14	Min:	2,14		
S/N: 004	✓	✓	20,7		58,8		2,45		2,52		✓	✓
S/N: 006	✓	✓	20,77		55,3		2,4		2,45		✓	✓
S/N: 007	✓	✓	19,85		55,7		2,32		2,31		✓	
S/N: 008	✓	✓	20,01		55,3		2,38		2,30		✓	
S/N: 009	✓	✓	19,89		55,2		2,44		2,30		✓	

Q08 – 14121040-1-C

TEST	Electrical Characteristics								Life Test	Dielectric Withstanding Voltage	Electrical Characteristics							
	Inductance μ H										Inductance μ H							
CONDITIONS	0,100V 300kHz								500V	§5.15	0,100V 300kHz							
LIMITS	N1		N2		N3		N4		Min: 5000		N1		N2		N3		N4	
	Max:	21,26	Max:	59,1	Max:	2,55	Max:	2,55			Max:	21,26	Max:	59,1	Max:	2,55	Max:	2,55
	Min:	19,24	Min:	53,4	Min:	2,14	Min:	2,14			Min:	19,24	Min:	53,4	Min:	2,14	Min:	2,14
S/N: 004	20,71		59,1		2,4		2,5		✓									
S/N: 006	20,7		55,3		2,3		2,4		✓									
S/N: 007									✓	✓	19,8	55,8	2,3	2,29				
S/N: 008									✓	✓	20,0	55,3	2,4	2,31				
S/N: 009									✓	✓	19,8	55,1	2,5	2,33				

TEST	Electrical Characteristics	Resistance to Solvents	Permanence of Marking	Vibration	Mechanical Shock	Visual Inspection
	Insul MOhm					
CONDITIONS	500V	§5.7	§5.9	§5.10	§5.11	§5.3
LIMITS	Min: 5000					
S/N: 004				✓	✓	✓
S/N: 006				✓	✓	✓
S/N: 007	✓	✓	✓			
S/N: 008	✓	✓	✓			
S/N: 009	✓	✓	✓			

Q08 – 14121040-1-C

TEST	Electrical Characteristics								Moisture Resistance	Electrical Characteristics									
	Inductance μ H									Insul MOhm	Inductance μ H								Insul MOhm
CONDITIONS	0,100V 300kHz								500V	§5.12	0,100V 300kHz								500V
LIMITS	N1	N2	N3	N4					N1		N2	N3	N4						
	Max:	21,26	Max:	59,1	Max:	2,55	Max:	2,55		Max:	21,26	Max:	59,1	Max:	2,55	Max:	2,55		
	Min:	19,24	Min:	53,4	Min:	2,14	Min:	2,14	Min: 5000	Min:	19,24	Min:	53,4	Min:	2,14	Min:	2,14	Min: 5000	
S/N: 004	20,6		59,0		2,3		2,4		✓	✓	20,7		58,8		2,4		2,4		✓
S/N: 006	20,5		55,2		2,3		2,4		✓	✓	20,6		55,2		2,3		2,3		✓
S/N: 007																			
S/N: 008																			
S/N: 009																			

Q08 – 14121040-1-C

TEST	Winding Continuity	Thermal Shock	Electrical Characteristics								Overload	Visual Inspection								
			Inductance μ H										Insul MOhm							
CONDITIONS	RD6	§5.4	0,100V 300kHz								500V	§5.13	§5.3							
LIMITS			N1	N2	N3	N4														
			Max:	21,26	Max:	59,1	Max:	2,55	Max:	2,55		Max:	21,26	Max:	59,1	Max:	2,55	Max:	2,55	
			Min:	19,24	Min:	53,4	Min:	2,14	Min:	2,14	Min: 5000	Min:	19,24	Min:	53,4	Min:	2,14	Min:	2,14	Min: 5000
S/N: 004	✓	✓	20,8		58,2		2,4		2,4		✓	✓	✓							
S/N: 006	✓	✓	20,7		55,2		2,3		2,3		✓	✓	✓							
S/N: 007																				
S/N: 008																				
S/N: 009																				

Q08 – 14121040-1-C

TEST	Electrical Characteristics								DPA	
	Inductance μH							Insul MOhm		
CONDITIONS	0,100V 300kHz							500V	§5.18	
LIMITS	N1		N2		N3		N4			
	Max:	21,26	Max:	59,1	Max:	2,55	Max:	2,55		
	Min:	19,24	Min:	53,4	Min:	2,14	Min:	2,14	Min: 5000	
S/N: 004	20,7		58,1		2,3		2,4		✓	✓
S/N: 006	20,6		55,4		2,2		2,3		✓	
S/N: 007										
S/N: 008										
S/N: 009										

11.9 Q09 – 12385000-1-C

TEST	Solderability	Terminal Strength	Visual Inspection	Electrical Characteristics		Insulation Resistance	Visual Inspection	Dielectric Withstanding Voltage
				Inductance μ H	Insul MOhm			
CONDITIONS	§5.6	§5.8	§5.3	0,250V 10kHz N1	500V	§5.17	§5.3	§5.5 60s @ 500V
LIMITS				Max: 133,7				
				Min: 109,4	Min: 5000			
S/N: 013	✓		✓	118,1	✓	✓	✓	✓
S/N: 014	✓		✓	116,6	✓	✓	✓	✓
S/N: 015	✓		✓	116,3	✓	✓	✓	✓
S/N: 016	✓		✓	118	✓	✓	✓	✓
S/N: 017	✓		✓	116,4	✓	✓	✓	✓

TEST	Electrical Characteristics		Mounting on PCB	Visual Inspection	Electrical Characteristics		Life	Dielectric Withstanding Voltage
	Inductance μ H	Insul MOhm			Inductance μ H	Insul MOhm		
CONDITIONS	0,250V 10kHz N1	500V		§5.3	0,250V 10kHz N1	500V	§5.15	§5.5 5s @ 375V
LIMITS	Max: 133,7				Max: 133,7			
	Min: 109,4	Min: 5000			Min: 109,4	Min: 5000		
S/N: 013	117,9	✓	✓	✓	117,2	✓		
S/N: 014	116,4	✓	✓	✓	116,2	✓		
S/N: 015	116,2	✓					✓	✓
S/N: 016	117,9	✓					✓	✓
S/N: 017	116,7	✓					✓	✓

Q09 – 12385000-1-C

TEST	Electrical Characteristics		Resistance to Solvents	Permanence of Marking	Vibration	Mechanical Shock	Visual Inspection	Electrical Characteristics	
	Inductance μ H	Insul MOhm						Inductance μ H	Insul MOhm
CONDITIONS	0,250V 10kHz N1	500V	§5.7	§5.9	§5.10	§5.11	§5.3	0,250V 10kHz N1	500V
LIMITS	Max: 133,7							Max: 133,7	
	Min: 109,4	Min: 5000						Min: 109,4	Min: 5000
S/N: 013					✓	✓	✓	117,0	✓
S/N: 014					✓	✓	✓	116,4	✓
S/N: 015	116,4	✓	✓	✓					
S/N: 016	118,2	✓	✓	✓					
S/N: 017	116,5	✓	✓	✓					

TEST	Moisture Resistance	Electrical Characteristics		Winding Continuity	Thermal Shock	Electrical Characteristics		Partial Discharge	Temp Rise
		Inductance μ H	Insul MOhm			Inductance μ H	Insul MOhm		
CONDITIONS	§5.12	0,250V 10kHz N1	500V	RD6	§5.4	0,250V 10kHz N1	500V	§5.16	§5.14
LIMITS		Max: 133,7				Max: 133,7			
		Min: 109,4	Min: 5000			Min: 109,4	Min: 5000		
S/N: 013	✓	116,9	✓	✓	✓	117,1	✓		
S/N: 014	✓	116,8	✓	✓	✓	116,5	✓		
S/N: 015									
S/N: 016									
S/N: 017									

Q09 – 12385000-1-C

TEST	Overload	Visual Inspection	Electrical Characteristics		DPA
			Inductance μ H	Insul MOhm	
CONDITIONS	§5.13	§5.3	0,250V 10kHz N1	500V	§5.18
LIMITS			Max: 133,7		
			Min: 109,4	Min: 5000	
S/N: 013	✓	✓	117,2	✓	✓
S/N: 014	✓	✓	116,9	✓	
S/N: 015					
S/N: 016					
S/N: 017					

11.10 Q10 – 14179033-1-C

TEST	Solderability	Terminal Strength	Visual Inspection	Electrical Characteristics			Insulation Resistance	Visual Inspection	Dielectric Withstanding Voltage	
				Inductance μ H						Insul MOhm
CONDITIONS	§5.6	§5.8	§5.3	0,250V 100kHz			500V	§5.17	§5.3	§5.5 60s @ 300V
				N1	N2	N3				
LIMITS				Max: 32,3	Max: 8,09	Max: 8,09				
				Min: 27,6	Min: 6,89	Min: 6,89	Min: 5000			
S/N: 128	✓	✓	✓	29,4	7,41	7,52	✓	✓	✓	✓
S/N: 129	✓	✓	✓	29,2	7,39	7,47	✓	✓	✓	✓
S/N: 130	✓	✓	✓	29,5	7,45	7,59	✓	✓	✓	✓
S/N: 131	✓	✓	✓	29,2	7,39	7,5	✓	✓	✓	✓
S/N: 132	✓	✓	✓	29,1	7,35	7,45	✓	✓	✓	✓

TEST	Electrical Characteristics				Mounting on PCB	Visual Inspection	Electrical Characteristics				Life	Dielectric Withstanding Voltage
	Inductance μ H			Insul MOhm			Inductance μ H			Insul MOhm		
CONDITIONS	0,250V 100kHz			500V		§5.3	0,250V 100kHz			500V	§5.15	§5.5 5s @ 225V
	N1	N2	N3				N1	N2	N3			
LIMITS	Max: 32,3	Max: 8,09	Max: 8,09				Max: 32,3	Max: 8,09	Max: 8,09			
	Min: 27,6	Min: 6,89	Min: 6,89	Min: 5000			Min: 27,6	Min: 6,89	Min: 6,89	Min: 5000		
S/N: 128	29,1	7,44	7,53	✓	✓	✓	29,47	7,37	7,52	✓		
S/N: 129	29,6	7,42	7,51	✓	✓	✓	29,23	7,32	7,41	✓		
S/N: 130	29,4	7,49	7,51	✓							✓	✓
S/N: 131	29,1	7,32	7,52	✓							✓	✓
S/N: 132	28,9	7,28	7,35	✓							✓	✓

Q10 – 14179033-1-C

TEST	Electrical Characteristics			Resistance to Solvents	Permanence of Marking	Vibration	Mechanical Shock	Visual Inspection	Electrical Characteristics				
	Inductance μ H		Insul MOhm						Inductance μ H		Insul MOhm		
CONDITIONS	0,250V 100kHz			500V	§5.7	§5.9 N2	§5.10	§5.11	§5.3 N3	0,250V 100kHz		500V	
	N2	N2	N2						N1	N2	N3		
LIMITS	Max: 32,3	Max: 8,09	Max: 8,09						Max: 32,3	Max: 8,09	Max: 8,09		
	Min: 27,6	Min: 6,89	Min: 6,89	Min: 5000					Min: 27,6	Min: 6,89	Min: 6,89	Min: 5000	
S/N: 128							✓	✓	✓	29,49	7,38	7,50	✓
S/N: 129							✓	✓	✓	29,22	7,31	7,40	✓
S/N: 130	29,3	7,51	7,52	✓	✓	✓							
S/N: 131	29,2	7,36	7,51	✓	✓	✓							
S/N: 132	29,1	7,29	7,46	✓	✓	✓							

TEST	Moisture Resistance	Electrical Characteristics			Winding Continuity	Thermal Shock	Electrical Characteristics			Partial Discharge	
		Inductance μ H		Insul MOhm			Inductance μ H		Insul MOhm		
CONDITIONS	§5.12	0,250V 100kHz			500V	RD6	§5.4	0,250V 100kHz		500V	§5.16
		N1	N2	N3				N1	N2	N3	
LIMITS		Max: 32,3	Max: 8,09	Max: 8,09				Max: 32,3	Max: 8,09	Max: 8,09	
		Min: 27,6	Min: 6,89	Min: 6,89	Min: 5000			Min: 27,6	Min: 6,89	Min: 6,89	Min: 5000
S/N: 128	✓	29,48	7,36	7,52	✓	✓	✓	29,47	7,37	7,51	✓
S/N: 129	✓	29,24	7,33	7,41	✓	✓	✓	29,23	7,32	7,43	✓
S/N: 130											
S/N: 131											
S/N: 132											

Q10 – 14179033-1-C

TEST	Temp Rise	Overload	Visual Inspection	Electrical Characteristics			DPA	
				Inductance μ H				Insul MOhm
CONDITIONS	§5.14	§5.13	§5.3	0,250V 100kHz			500V	§5.18
				N1	N2	N3		
LIMITS				Max: 32,3	Max: 8,09	Max: 8,09		
				Min: 27,6	Min: 6,89	Min: 6,89	Min: 5000	
S/N: 128		✓	✓	29,45	7,38	7,50	✓	✓
S/N: 129		✓	✓	29,21	7,33	7,44	✓	✓
S/N: 130								
S/N: 131								
S/N: 132								

11.11 Q11 – 12251055-1-B

TEST	Solderability	Terminal Strength	Visual Inspection	Electrical Characteristics		Insulation Resistance	Visual Inspection	Dielectric Withstanding Voltage
				Inductance μ H	Insul MOhm			
CONDITIONS	§5.6	§5.8	§5.3	0,250V 100kHz N1	500V	§5.17	§5.3	§5.5 60s @ 500V
LIMITS				Max: 141,5				
				Min: 115,8	Min: 5000			
S/N: 047	✓		✓	124,4	✓	✓	✓	✓
S/N: 048	✓		✓	123,8	✓	✓	✓	✓
S/N: 049	✓		✓	127,4	✓	✓	✓	✓
S/N: 050	✓		✓	125,8	✓	✓	✓	✓
S/N: 051	✓		✓	121,9	✓	✓	✓	✓

TEST	Electrical Characteristics		Mounting on PCB	Visual Inspection	Electrical Characteristics		Life	Dielectric Withstanding Voltage
	Inductance μ H	Insul MOhm			Inductance μ H	Insul MOhm		
CONDITIONS	0,250V 100kHz N1	500V		§5.3	0,250V 100kHz N1	500V	§5.15	§5.5 5s @ 375V
LIMITS	Max: 141,5				Max: 141,5			
	Min: 115,8	Min: 5000			Min: 115,8	Min: 5000		
S/N: 047	124,9	✓	✓	✓	125,2	✓		
S/N: 048	124,2	✓	✓	✓	126,0	✓		
S/N: 049	126,4						✓	✓
S/N: 050	127,8						✓	✓
S/N: 051	119,9						✓	✓

Q11 – 12251055-1-B

TEST	Electrical Characteristics		Resistance to Solvents	Permanence of Marking	Vibration	Mechanical Shock	Visual Inspection	Electrical Characteristics	
	Inductance μ H	Insul MOhm						Inductance μ H	Insul MOhm
CONDITIONS	0,250V 100kHz N1	500V	§5.7	§5.9	§5.10	§5.11	§5.3	0,250V 100kHz N1	500V
LIMITS	Max: 141,5							Max: 141,5	
	Min: 115,8	Min: 5000						Min: 115,8	Min: 5000
S/N: 047					✓	✓	✓	125,0	✓
S/N: 048					✓	✓	✓	126,1	✓
S/N: 049	127,8	✓	✓	✓					
S/N: 050	126,2	✓	✓	✓					
S/N: 051	122,2	✓	✓	✓					

TEST	Moisture Resistance	Electrical Characteristics		Winding Continuity	Thermal Shock	Electrical Characteristics		Partial Discharge	Temp Rise
		Inductance μ H	Insul MOhm			Inductance μ H	Insul MOhm		
CONDITIONS	§5.12	0,250V 100kHz N1	500V	RD6	§5.4	0,250V 100kHz N1	500V	§5.16	§5.14
LIMITS		Max: 141,5				Max: 141,5			
		Min: 115,8	Min: 5000			Min: 115,8	Min: 5000		
S/N: 047	✓	125,1	✓	✓	✓	124,7	✓		
S/N: 048	✓	126,0	✓	✓	✓	126,3	✓		
S/N: 049									
S/N: 050									
S/N: 051									

Q11 – 12251055-1-B

TEST	Overload	Visual Inspection	Electrical Characteristics		DPA
			Inductance μ H	Insul MOhm	
CONDITIONS	§5.13	§5.3	0,250V 10kHz N1	500V	§5.18
LIMITS			Max: 141,5		
			Min: 115,8	Min: 5000	
S/N: 047	✓	✓	124,8	✓	✓
S/N: 048	✓	✓	126,0	✓	
S/N: 049					
S/N: 050					
S/N: 051					

11.12 Q12 – 12141076-3-B

TEST	Solderability	Terminal Strength	Visual Inspection	Electrical Characteristics		Insulation Resistance	Visual Inspection	Dielectric Withstanding Voltage
				Inductance μH	Insul MOhm			
CONDITIONS	§5.6	§5.8	§5.3	0,250V 100kHz N1	500V	§5.17	§5.3	§5.5 60s @ 500V
LIMITS				Max: 17,82				
				Min: 14,58	Min: 5000			
S/N: 378	✓		✓	16,56	✓	✓	✓	✓
S/N: 379	✓		✓	16,79	✓	✓	✓	✓
S/N: 380	✓		✓	16,65	✓	✓	✓	✓
S/N: 381	✓		✓	16,48	✓	✓	✓	✓
S/N: 382	✓		✓	16,55	✓	✓	✓	✓

TEST	Electrical Characteristics		Mounting on PCB	Visual Inspection	Electrical Characteristics		Life	Dielectric Withstanding Voltage
	Inductance μH	Insul MOhm			Inductance μH	Insul MOhm		
CONDITIONS	0,250V 100kHz N1	500V		§5.3	0,250V 100kHz N1	500V	§5.15	§5.5 5s @ 375V
LIMITS	Max: 17,82				Max: 17,82			
	Min: 14,58	Min: 5000			Min: 14,58	Min: 5000		
S/N: 378	16,56	✓	✓	✓	16,5	✓		
S/N: 379	16,79	✓	✓	✓	16,8	✓		
S/N: 380	16,65						✓	✓
S/N: 381	16,48						✓	✓
S/N: 382	16,55						✓	✓

Q12 – 12141076-3-B

TEST	Electrical Characteristics		Resistance to Solvents	Permanence of Marking	Vibration	Mechanical Shock	Visual Inspection	Electrical Characteristics	
	Inductance μ H	Insul MOhm						Inductance μ H	Insul MOhm
CONDITIONS	0,250V 100kHz N1	500V	§5.7	§5.9	§5.10	§5.11	§5.3	0,250V 100kHz N1	500V
LIMITS	Max: 17,82							Max: 17,82	
	Min: 14,58	Min: 5000						Min: 14,58	Min: 5000
S/N: 378					✓	✓	✓	16,4	✓
S/N: 379					✓	✓	✓	16,8	✓
S/N: 380	16,63	✓	✓	✓					
S/N: 381	16,48	✓	✓	✓					
S/N: 382	16,58	✓	✓	✓					

TEST	Moisture Resistance	Electrical Characteristics		Winding Continuity	Thermal Shock	Electrical Characteristics		Partial Discharge	Temp Rise
		Inductance μ H	Insul MOhm			Inductance μ H	Insul MOhm		
CONDITIONS	§5.12	0,250V 100kHz N1	500V	RD6	§5.4	0,250V 100kHz N1	500V	§5.16	§5.14
LIMITS		Max: 17,82				Max: 17,82			
		Min: 14,58	Min: 5000			Min: 14,58	Min: 5000		
S/N: 378	✓	16,5	✓	✓	✓	16,4	✓		
S/N: 379	✓	16,8	✓	✓	✓	16,9	✓		
S/N: 380									
S/N: 381									
S/N: 382									

Q12 – 12141076-3-B

TEST	Overload	Visual Inspection	Electrical Characteristics		DPA
			Inductance μ H	Insul MOhm	
CONDITIONS	§5.13	§5.3	0,250V 100kHz N1	500V	§5.18
LIMITS			Max: 17,82		
			Min: 14,58	Min: 5000	
S/N: 378	✓	✓	16,6	✓	✓
S/N: 379	✓	✓	16,8	✓	
S/N: 380					
S/N: 381					
S/N: 382					

11.13 Q13 – 12311081-1-B

TEST	Solderability	Terminal Strength	Visual Inspection	Electrical Characteristics		Insulation Resistance	Visual Inspection	Dielectric Withstanding Voltage	
				Inductance μH	Insul MOhm				
CONDITIONS	§5.6	§5.8	§5.3	0,050V 10kHz N1 N2		500V	§5.17	§5.3	§5.5 60s @ 500V
LIMITS				Max: 145,2	Max: 155,4				
				Min: 118,8	Min: 127,2	Min: 5000			
S/N: 065	✓		✓	124,7	133,9	✓	✓	✓	✓
S/N: 066	✓		✓	124,7	134,1	✓	✓	✓	✓
S/N: 067	✓		✓	124,2	133,4	✓	✓	✓	✓
S/N: 068	✓		✓	125,1	134,2	✓	✓	✓	✓
S/N: 069	✓		✓	124,7	133,9	✓	✓	✓	✓

TEST	Electrical Characteristics		Mounting on PCB	Visual Inspection	Electrical Characteristics		Life	Dielectric Withstanding Voltage	
	Inductance μH	Insul MOhm			Inductance μH	Insul MOhm			
CONDITIONS	0,050V 10kHz N1 N2			§5.3	0,050V 10kHz N1 N2		500V	§5.15	§5.5 5s @ 375V
LIMITS	Max: 145,2	Max: 155,4			Max: 145,2	Max: 155,4			
	Min: 118,8	Min: 127,2	Min: 5000		Min: 118,8	Min: 127,2	Min: 5000		
S/N: 065	123,3	133,9	✓	✓	123,0	133,0	✓		
S/N: 066	124,8	134,5	✓	✓	124,2	134,2	✓		
S/N: 067	124,0	133,2	✓					✓	
S/N: 068	125,2	133,9	✓					✓	
S/N: 069	124,6	134,1	✓					✓	

Q13 – 12311081-1-B

TEST	Electrical Characteristics		Resistance to Solvents	Permanence of Marking	Vibration	Mechanical Shock	Visual Inspection	Electrical Characteristics		
	Inductance μ H	Insul MOhm						Inductance μ H	Insul MOhm	
CONDITIONS	0,050V 10kHz N1 N2		500V	§5.7	§5.9	§5.10	§5.11	§5.3	0,050V 10kHz N1 N2	500V
LIMITS	Max: 145,2	Max: 155,4							Max: 145,2	Max: 155,4
	Min: 118,8	Min: 127,2	Min: 5000						Min: 118,8	Min: 127,2
S/N: 065					✓	✓	✓	123,4	133,3	✓
S/N: 066					✓	✓	✓	124,8	134,4	✓
S/N: 067	125,1	134,2	✓	✓	✓					
S/N: 068	124,8	134,1	✓	✓	✓					
S/N: 069	124,2	133,4	✓	✓	✓					

TEST	Moisture Resistance	Electrical Characteristics		Winding Continuity	Thermal Shock	Electrical Characteristics		Partial Discharge	Temp Rise	
		Inductance μ H	Insul MOhm			Inductance μ H	Insul MOhm			
CONDITIONS	§5.12	0,050V 10kHz N1 N2		500V	RD6	§5.4	0,050V 10kHz N1 N2	500V	§5.16	§5.14
LIMITS		Max: 145,2	Max: 155,4				Max: 145,2	Max: 155,4		
		Min: 118,8	Min: 127,2	Min: 5000			Min: 118,8	Min: 127,2	Min: 5000	
S/N: 065	✓	123,4	133,1	✓	✓	✓	123,5	133,2	✓	
S/N: 066	✓	124,8	134,5	✓	✓	✓	124,9	134,5	✓	
S/N: 067										
S/N: 068										
S/N: 069										

Q13 – 12311081-1-B

TEST	Overload	Visual Inspection	Electrical Characteristics		DPA	
			Inductance μ H			Insul MOhm
CONDITIONS	§5.13	§5.3	0,050V 10kHz		500V	§5.18
LIMITS			N1	N2		
			Max: 145,2	Max: 155,4		
			Min: 118,8	Min: 127,2	Min: 5000	
S/N: 065	✓	✓	123,6	133,2	✓	✓
S/N: 066	✓	✓	124,7	134,1	✓	
S/N: 067						
S/N: 068						
S/N: 069						

11.14 Q14 – 12011041-1-B

TEST	Solderability	Terminal Strength	Visual Inspection	Electrical Characteristics		Insulation Resistance	Visual Inspection	Dielectric Withstanding Voltage
				Inductance μH	Insul MOhm			
CONDITIONS	§5.6	§5.8	§5.3	0,100V 10kHz N1	500V	§5.17	§5.3	§5.5 60s @ 500V
LIMITS				Max: 120,0				
				Min: 89,1	Min: 5000			
S/N: 071	✓		✓	115	✓	✓	✓	✓
S/N: 072	✓		✓	116,4	✓	✓	✓	✓
S/N: 073	✓		✓	111,4	✓	✓	✓	✓
S/N: 074	✓		✓	106,2	✓	✓	✓	✓
S/N: 075	✓		✓	105,3	✓	✓	✓	✓

TEST	Electrical Characteristics		Mounting on PCB	Visual Inspection	Electrical Characteristics		Life	Dielectric Withstanding Voltage
	Inductance μH	Insul MOhm			Inductance μH	Insul MOhm		
CONDITIONS	0,100V 10kHz N1	500V		§5.3	0,100V 10kHz N1	500V	§5.15	§5.5 5s @ 375V
LIMITS	Max: 120,0				Max: 120,0			
	Min: 89,1	Min: 5000			Min: 89,1	Min: 5000		
S/N: 071	114,0	✓	✓	✓	113,2	✓		
S/N: 072	115,4	✓	✓	✓	113,1	✓		
S/N: 073	110,4	✓					✓	✓
S/N: 074	105,2	✓					✓	✓
S/N: 075	102,3	✓					✓	✓

Q14 – 12011041-1-B

TEST	Electrical Characteristics		Resistance to Solvents	Permanence of Marking	Vibration	Mechanical Shock	Visual Inspection	Electrical Characteristics	
	Inductance μ H	Insul MOhm						Inductance μ H	Insul MOhm
CONDITIONS	0,100V 10kHz N1	500V	§5.7	§5.9	§5.10	§5.11	§5.3	0,100V 10kHz N1	500V
LIMITS	Max: 120,0							Max: 120,0	
	Min: 89,1	Min: 5000						Min: 89,1	Min: 5000
S/N: 071					✓	✓	✓	113,2	✓
S/N: 072					✓	✓	✓	113,1	✓
S/N: 073	113,2	✓	✓	✓					
S/N: 074	107,7	✓	✓	✓					
S/N: 075	106,7	✓	✓	✓					

TEST	Moisture Resistance	Electrical Characteristics		Winding Continuity	Thermal Shock	Electrical Characteristics		Partial Discharge	Temp Rise
		Inductance μ H	Insul MOhm			Inductance μ H	Insul MOhm		
CONDITIONS	§5.12	0,100V 10kHz N1	500V	RD6	§5.4	0,100V 10kHz N1	500V	§5.16	§5.14
LIMITS		Max: 120,0				Max: 120,0			
		Min: 89,1	Min: 5000			Min: 89,1	Min: 5000		
S/N: 071	✓	113,1	✓	✓	✓	113,2	✓		
S/N: 072	✓	113,0	✓	✓	✓	113,1	✓		
S/N: 073									
S/N: 074									
S/N: 075									

Q14 – 12011041-1-B

TEST	Overload	Visual Inspection	Electrical Characteristics		DPA
			Inductance μ H	Insul MOhm	
CONDITIONS	§5.13	§5.3	0,100V 10kHz N1	500V	§5.18
LIMITS			Max: 120,0		
			Min: 89,1	Min: 5000	
S/N: 071	✓	✓	113,1	✓	✓
S/N: 072	✓	✓	113,0	✓	
S/N: 073					
S/N: 074					
S/N: 075					

11.15 Q15 – 14110319-1-B

TEST	Solderability	Terminal Strength	Visual Inspection	Electrical Characteristics		Insulation Resistance	Visual Inspection	Dielectric Withstanding Voltage
				Inductance μH	Insul MOhm			
CONDITIONS	§5.6	§5.8	§5.3	0,050V 10kHz N1	500V	§5.17	§5.3	§5.5 60s @ 300V
LIMITS				Max: 4119				
				Min: 1972	Min: 10			
S/N: 012	✓	✓	✓	3061	✓	✓	✓	✓
S/N: 013	✓	✓	✓	3085	✓	✓	✓	✓
S/N: 015	✓	✓	✓	3155	✓	✓	✓	✓
S/N: 016	✓	✓	✓	3549	✓	✓	✓	✓
S/N: 017	✓	✓	✓	3127	✓	✓	✓	✓

TEST	Electrical Characteristics		Mounting on PCB	Visual Inspection	Electrical Characteristics		Life	Dielectric Withstanding Voltage
	Inductance μH	Insul MOhm			Inductance μH	Insul MOhm		
CONDITIONS	0,050V 10kHz N1	500V		§5.3	0,050V 10kHz N1	500V	§5.15	§5.5 5s @ 225V
LIMITS	Max: 4119				Max: 4119			
	Min: 1972	Min: 10			Min: 1972	Min: 10		
S/N: 012	3050	✓	✓	✓	3040	✓		
S/N: 013	3068	✓	✓	✓	3062	✓		
S/N: 015	3099	✓					✓	✓
S/N: 016	3623	✓					✓	✓
S/N: 017	3248	✓					✓	✓

Q15 – 14110319-1-B

TEST	Electrical Characteristics		Resistance to Solvents	Permanence of Marking	Vibration	Mechanical Shock	Visual Inspection	Electrical Characteristics	
	Inductance μ H	Insul MOhm						Inductance μ H	Insul MOhm
CONDITIONS	0,050V 10kHz N1	500V	§5.7	§5.9	§5.10	§5.11	§5.3	0,050V 10kHz N1	500V
LIMITS	Max: 4119							Max: 4119	
	Min: 1972	Min: 10						Min: 1972	Min: 10
S/N: 012					✓	✓	✓	3068	✓
S/N: 013					✓	✓	✓	3081	✓
S/N: 015	3538	✓	✓	✓					
S/N: 016	3148	✓	✓	✓					
S/N: 017	3325	✓	✓	✓					

TEST	Moisture Resistance	Electrical Characteristics		Winding Continuity	Thermal Shock	Electrical Characteristics		Partial Discharge	Temp Rise
		Inductance μ H	Insul MOhm			Inductance μ H	Insul MOhm		
CONDITIONS	§5.12	0,050V 10kHz N1	500V	RD6	§5.4	0,050V 10kHz N1	500V	§5.16	§5.14
LIMITS		Max: 4119				Max: 4119			
		Min: 1972	Min: 10			Min: 1972	Min: 10		
S/N: 012	✓	3077	✓	✓	✓	3088	✓		
S/N: 013	✓	3092	✓	✓	✓	3102	✓		
S/N: 015									
S/N: 016									
S/N: 017									

Q15 – 14110319-1-B

TEST	Overload	Visual Inspection	Electrical Characteristics		DPA
			Inductance μ H	Insul MOhm	
CONDITIONS	§5.13	§5.3	0,100V 10kHz N1	500V	§5.18
LIMITS			Max: 4119		
			Min: 1972	Min: 10	
S/N: 012	✓	✓	3078	✓	✓
S/N: 013	✓	✓	3099	✓	
S/N: 015					
S/N: 016					
S/N: 017					

11.16 Q16 – 14170338-2-B

TEST	Solderability	Terminal Strength	Visual Inspection	Electrical Characteristics		Insulation Resistance	Visual Inspection	Dielectric Withstanding Voltage
				Inductance μH	Insul MOhm			
CONDITIONS	§5.6	§5.8	§5.3	0,250V 100kHz P1	500V	§5.17	§5.3	§5.5 60s @ 500V
LIMITS				Max: 176,0				
				Min: 144,0	Min: 5000			
S/N: 007	✓	✓	✓	161,5	✓	✓	✓	✓
S/N: 008	✓	✓	✓	159	✓	✓	✓	✓
S/N: 009	✓	✓	✓	160	✓	✓	✓	✓
S/N: 010	✓	✓	✓	161,6	✓	✓	✓	✓
S/N: 011	✓	✓	✓	158,5	✓	✓	✓	✓

TEST	Electrical Characteristics		Mounting on PCB	Visual Inspection	Electrical Characteristics		Life	Dielectric Withstanding Voltage
	Inductance μH	Insul MOhm			Inductance μH	Insul MOhm		
CONDITIONS	0,250V 100kHz P1	500V		§5.3	0,250V 100kHz P1	500V	§5.15	§5.5 5s @ 375V
LIMITS	Max: 176,0				Max: 176,0			
	Min: 144,0	Min: 5000			Min: 144,0	Min: 5000		
S/N: 007	159	✓	✓	✓	157	✓		
S/N: 008	152	✓	✓	✓	150	✓		
S/N: 009	163	✓					✓	✓
S/N: 010	160	✓					✓	✓
S/N: 011	157	✓					✓	✓

Q16 – 14170338-2-B

TEST	Electrical Characteristics		Resistance to Solvents	Permanence of Marking	Vibration	Mechanical Shock	Visual Inspection	Electrical Characteristics	
	Inductance μ H	Insul MOhm						Inductance μ H	Insul MOhm
CONDITIONS	0,250V 100kHz P1	500V	§5.7	§5.9	§5.10	§5.11	§5.3	0,250V 100kHz P1	500V
LIMITS	Max: 176,0							Max: 176,0	
	Min: 144,0	Min: 5000						Min: 144,0	Min: 5000
S/N: 007					✓	✓	✓	160,1	
S/N: 008					✓	✓	✓	158,1	
S/N: 009	158,4	✓	✓	✓					
S/N: 010	155,8	✓	✓	✓					
S/N: 011	160,0	✓	✓	✓					

TEST	Moisture Resistance	Electrical Characteristics		Winding Continuity	Thermal Shock	Electrical Characteristics		Partial Discharge	Temp Rise
		Inductance μ H	Insul MOhm			Inductance μ H	Insul MOhm		
CONDITIONS	§5.12	0,250V 100kHz P1	500V	RD6	§5.4	0,250V 100kHz P1	500V	§5.16	§5.14
LIMITS		Max: 176,0				Max: 176,0			
		Min: 144,0	Min: 5000			Min: 144,0	Min: 5000		
S/N: 007	✓	160,1	✓	✓	✓	160,1	✓		
S/N: 008	✓	158,1	✓	✓	✓	158,1	✓		
S/N: 009									
S/N: 010									
S/N: 011									

Q16 – 14170338-2-B

TEST	Overload	Visual Inspection	Electrical Characteristics		DPA
			Inductance μ H	Insul MOhm	
CONDITIONS	§5.13	§5.3	0,250V 100kHz P1	500V	§5.18
LIMITS			Max: 176,0		
			Min: 144,0	Min: 5000	
S/N: 007	✓	✓	160,0	✓	✓
S/N: 008	✓	✓	158,2	✓	
S/N: 009					
S/N: 010					
S/N: 011					

11.17 Q17 – 14220171-1-B

TEST	Solderability	Terminal Strength	Visual Inspection	Electrical Characteristics		Insulation Resistance	Visual Inspection	Dielectric Withstanding Voltage
				Inductance μH	Insul MOhm			
CONDITIONS	§5.6	§5.8	§5.3	0,050V 10kHz N1	500V	§5.17	§5.3	§5.5 60s @ 500V
LIMITS				Max: 22,38				
				Min: 18,23	Min: 5000			
S/N: 140	✓		✓	20,18	✓	✓	✓	✓
S/N: 141	✓		✓	20,2	✓	✓	✓	✓
S/N: 142	✓		✓	20,14	✓	✓	✓	✓
S/N: 143	✓		✓	20,33	✓	✓	✓	✓
S/N: 144	✓		✓	20,00	✓	✓	✓	✓

TEST	Electrical Characteristics		Mounting on PCB	Visual Inspection	Electrical Characteristics		Life	Dielectric Withstanding Voltage
	Inductance μH	Insul MOhm			Inductance μH	Insul MOhm		
CONDITIONS	0,050V 10kHz N1	500V		§5.3	0,050V 10kHz N1	500V	§5.15	§5.5 5s @ 375V
LIMITS	Max: 22,38				Max: 22,38			
	Min: 18,23	Min: 5000			Min: 18,23	Min: 5000		
S/N: 140	20,00	✓	✓	✓	20,10	✓		
S/N: 141	19,90	✓	✓	✓	19,70	✓		
S/N: 142	20,29	✓					✓	✓
S/N: 143	20,19	✓					✓	✓
S/N: 144	20,07	✓					✓	✓

Q17 – 14220171-1-B

TEST	Electrical Characteristics		Resistance to Solvents	Permanence of Marking	Vibration	Mechanical Shock	Visual Inspection	Electrical Characteristics	
	Inductance μ H	Insul MOhm						Inductance μ H	Insul MOhm
CONDITIONS	0,050V 10kHz N1	500V	§5.7	§5.9	§5.10	§5.11	§5.3	0,050V 10kHz N1	500V
LIMITS	Max: 22,38							Max: 22,38	
	Min: 18,23	Min: 5000						Min: 18,23	Min: 5000
S/N: 140					✓	✓	✓	19,90	✓
S/N: 141					✓	✓	✓	19,80	✓
S/N: 142	20,32	✓	✓	✓					
S/N: 143	20,23	✓	✓	✓					
S/N: 144	20,11	✓	✓	✓					

TEST	Moisture Resistance	Electrical Characteristics		Winding Continuity	Thermal Shock	Electrical Characteristics		Partial Discharge	Temp Rise
		Inductance μ H	Insul MOhm			Inductance μ H	Insul MOhm		
CONDITIONS	§5.12	0,050V 10kHz N1	500V	RD6	§5.4	0,050V 10kHz N1	500V	§5.16	§5.14
LIMITS		Max: 22,38				Max: 22,38			
		Min: 18,23	Min: 5000			Min: 18,23	Min: 5000		
S/N: 140	✓	20,01	✓	✓	✓	19,94	✓		
S/N: 141	✓	20,12	✓	✓	✓	20,11	✓		
S/N: 142									
S/N: 143									
S/N: 144									

Q17 – 14220171-1-B

TEST	Overload	Visual Inspection	Electrical Characteristics		DPA
			Inductance μ H	Insul MOhm	
CONDITIONS	§5.13	§5.3	0,050V 10kHz N1	500V	§5.18
LIMITS			Max: 22,38		
			Min: 18,23	Min: 5000	
S/N: 140	✓	✓	19,82	✓	✓
S/N: 141	✓	✓	19,99	✓	✓
S/N: 142					
S/N: 143					
S/N: 144					

11.18 Q18 – 12180007-2-C

TEST	Solderability	Terminal Strength	Visual Inspection	Electrical Characteristics		Insulation Resistance	Visual Inspection	Dielectric Withstanding Voltage
				Inductance μH	Insul MOhm			
CONDITIONS	§5.6	§5.8	§5.3	0,100V 100kHz N1	500V	§5.17	§5.3	§5.5 60s @ 300V
LIMITS				Max: 6,80				
				Min: 4,44	Min: 5000			
S/N: 114	✓		✓	6,03	✓	✓	✓	✓
S/N: 116	✓		✓	6,08	✓	✓	✓	✓
S/N: 117	✓		✓	6,18	✓	✓	✓	✓
S/N: 118	✓		✓	6,00	✓	✓	✓	✓
S/N: 119	✓		✓	6,22	✓	✓	✓	✓

TEST	Electrical Characteristics		Mounting on PCB	Visual Inspection	Electrical Characteristics		Life	Dielectric Withstanding Voltage
	Inductance μH	Insul MOhm			Inductance μH	Insul MOhm		
CONDITIONS	0,100V 100kHz N1	500V		§5.3	0,100V 100kHz N1	500V	§5.15	§5.5 5s @ 225V
LIMITS	Max: 6,80				Max: 6,80			
	Min: 4,44	Min: 5000			Min: 4,44	Min: 5000		
S/N: 114	6,00	✓	✓	✓	5,98	✓		
S/N: 116	5,99	✓	✓	✓	5,90	✓		
S/N: 117	6,12	✓					✓	✓
S/N: 118	5,97	✓					✓	✓
S/N: 119	6,18	✓					✓	✓

Q18 – 12180007-2-C

TEST	Electrical Characteristics		Resistance to Solvents	Permanence of Marking	Vibration	Mechanical Shock	Visual Inspection	Electrical Characteristics	
	Inductance μ H	Insul MOhm						Inductance μ H	Insul MOhm
CONDITIONS	0,100V 100kHz N1	500V	§5.7	§5.9	§5.10	§5.11	§5.3	0,100V 100kHz N1	500V
LIMITS	Max: 6,80							Max: 6,80	
	Min: 4,44	Min: 5000						Min: 4,44	Min: 5000
S/N: 114					✓	✓	✓	5,92	✓
S/N: 116					✓	✓	✓	5,88	✓
S/N: 117	6,17	✓	✓	✓					
S/N: 118	6,02	✓	✓	✓					
S/N: 119	6,23	✓	✓	✓					

TEST	Moisture Resistance	Electrical Characteristics		Winding Continuity	Thermal Shock	Electrical Characteristics		Partial Discharge	Temp Rise
		Inductance μ H	Insul MOhm			Inductance μ H	Insul MOhm		
CONDITIONS	§5.12	0,100V 100kHz N1	500V	RD6	§5.4	0,100V 100kHz N1	500V	§5.16	§5.14
LIMITS		Max: 6,80				Max: 6,80			
		Min: 4,44	Min: 5000			Min: 4,44	Min: 5000		
S/N: 114	✓	5,92	✓	✓	✓	5,90	✓		
S/N: 116	✓	5,88	✓	✓	✓	5,82	✓		
S/N: 117									
S/N: 118									
S/N: 119									

Q18 – 12180007-2-C

TEST	Overload	Visual Inspection	Electrical Characteristics		DPA
			Inductance μ H	Insul MOhm	
CONDITIONS	§5.13	§5.3	0,100V 100kHz N1	500V	§5.18
LIMITS			Max: 6,80		
			Min: 4,44	Min: 5000	
S/N: 114	✓	✓	5,91	✓	✓
S/N: 116	✓	✓	5,89	✓	
S/N: 117					
S/N: 118					
S/N: 119					

11.19 Q19 – 12011018-5-C

TEST	Solderability	Terminal Strength	Visual Inspection	Electrical Characteristics		Insulation Resistance	Visual Inspection	Dielectric Withstanding Voltage
				Inductance μ H	Insul MOhm			
CONDITIONS	§5.6	§5.8	§5.3	0,020V 100kHz N1	500V	§5.17	§5.3	§5.5 60s @ 300V
LIMITS				Max: 42,2				
				Min: 21,8				
S/N: 00A	✓		✓	Pass		✓	✓	
S/N: 00B	✓		✓	Pass		✓	✓	
S/N: 00C	✓		✓	Pass		✓	✓	
S/N: 00D	✓		✓	Pass		✓	✓	
S/N: 00E	✓		✓	Pass		✓	✓	

TEST	Electrical Characteristics		Mounting on PCB	Visual Inspection	Electrical Characteristics		Life	Dielectric Withstanding Voltage
	Inductance μ H	Insul MOhm			Inductance μ H	Insul MOhm		
CONDITIONS	0,020V 100kHz N1	500V		§5.3	0,020V 100kHz N1	500V	§5.15	§5.5 5s @ 225V
LIMITS	Max: 42,2				Max: 42,2			
	Min: 21,8				Min: 21,8			
S/N: 00A	Pass		✓	✓	Pass			
S/N: 00B	Pass		✓	✓	Pass			
S/N: 00C	Pass						✓	
S/N: 00D	Pass						✓	
S/N: 00E	Pass						✓	

Q19 – 12011018-5-C

TEST	Electrical Characteristics		Resistance to Solvents	Permanence of Marking	Vibration	Mechanical Shock	Visual Inspection	Electrical Characteristics	
	Inductance μ H	Insul MOhm						Inductance μ H	Insul MOhm
CONDITIONS	0,020V 100kHz N1	500V	§5.7	§5.9	§5.10	§5.11	§5.3	0,020V 100kHz N1	500V
LIMITS	Max: 42,2							Max: 42,2	
	Min: 21,8							Min: 21,8	
S/N: 00A					✓	✓	✓	Pass	
S/N: 00B					✓	✓	✓	Pass	
S/N: 00C	Pass		N/A	N/A					
S/N: 00D	Pass		N/A	N/A					
S/N: 00E	Pass		N/A	N/A					

TEST	Moisture Resistance	Electrical Characteristics		Winding Continuity	Thermal Shock	Electrical Characteristics		Partial Discharge	Temp Rise
		Inductance μ H	Insul MOhm			Inductance μ H	Insul MOhm		
CONDITIONS	§5.12	0,020V 100kHz N1	500V	RD6	§5.4	0,020V 100kHz N1	500V	§5.16	§5.14
LIMITS		Max: 42,2				Max: 42,2			
		Min: 21,8				Min: 21,8			
S/N: 00A	✓	Pass		✓	✓	Pass			
S/N: 00B	✓	Pass		✓	✓	Pass			
S/N: 00C									
S/N: 00D									
S/N: 00E									

Q19 – 12011018-5-C

TEST	Overload	Visual Inspection	Electrical Characteristics		DPA
			Inductance μ H	Insul MOhm	
CONDITIONS	§5.13	§5.3	0,020V 100kHz N1	500V	§5.18
LIMITS			Max: 42,2		
			Min: 21,8		
S/N: 00A	✓	✓	Pass		✓
S/N: 00B	✓	✓	Pass		
S/N: 00C					
S/N: 00D					
S/N: 00E					

11.20 Q20 – 14110308-1-C

TEST	Solderability	Terminal Strength	Visual Inspection	Electrical Characteristics		Insulation Resistance	Visual Inspection	Dielectric Withstanding Voltage
				Inductance μH	Insul MOhm			
CONDITIONS	§5.6	§5.8	§5.3	0,250V 100kHz N1	500V	§5.17	§5.3	§5.5 60s @ 500V
LIMITS				Max: 43,0				
				Min: 38,9	Min: 5000			
S/N: 096	✓	✓	✓	40,7	✓	✓	✓	
S/N: 097	✓	✓	✓	40,5	✓	✓	✓	
S/N: 098	✓	✓	✓	40,1	✓	✓	✓	
S/N: 099	✓	✓	✓	40,4	✓	✓	✓	
S/N: 100	✓	✓	✓	40,4	✓	✓	✓	

TEST	Electrical Characteristics		Mounting on PCB	Visual Inspection	Electrical Characteristics		Life	Dielectric Withstanding Voltage
	Inductance μH	Insul MOhm			Inductance μH	Insul MOhm		
CONDITIONS	0,250V 100kHz N1	500V		§5.3	0,250V 100kHz N1	500V	§5.15	§5.5 5s @ 375V
LIMITS	Max: 43,0				Max: 43,0			
	Min: 38,9	Min: 5000			Min: 38,9	Min: 5000		
S/N: 096	40,6	✓	✓	✓	40,2	✓		
S/N: 097	40,6	✓	✓	✓	40,1	✓		
S/N: 098	40,2	✓					✓	
S/N: 099	40,5	✓					✓	
S/N: 100	40,5	✓					✓	

Q20 – 14110308-1-C

TEST	Electrical Characteristics		Resistance to Solvents	Permanence of Marking	Vibration	Mechanical Shock	Visual Inspection	Electrical Characteristics	
	Inductance μ H	Insul MOhm						Inductance μ H	Insul MOhm
CONDITIONS	0,250V 100kHz N1	500V	§5.7	§5.9	§5.10	§5.11	§5.3	0,250V 100kHz N1	500V
LIMITS	Max: 43,0							Max: 43,0	
	Min: 38,9	Min: 5000						Min: 38,9	Min: 5000
S/N: 096					✓	✓	✓	40,5	✓
S/N: 097					✓	✓	✓	40,5	✓
S/N: 098	40,4	✓	✓	✓					
S/N: 099	40,3	✓	✓	✓					
S/N: 100	40,4	✓	✓	✓					

TEST	Moisture Resistance	Electrical Characteristics		Winding Continuity	Thermal Shock	Electrical Characteristics		Partial Discharge	Temp Rise
		Inductance μ H	Insul MOhm			Inductance μ H	Insul MOhm		
CONDITIONS	§5.12	0,250V 100kHz N1	500V	RD6	§5.4	0,250V 100kHz N1	500V	§5.16	§5.14
LIMITS		Max: 43,0				Max: 43,0			
		Min: 38,9	Min: 5000			Min: 38,9	Min: 5000		
S/N: 096	✓	40,6	✓	✓	✓	40,4	✓		
S/N: 097	✓	40,6	✓	✓	✓	40,5	✓		
S/N: 098									
S/N: 099									
S/N: 100									

Q20 – 14110308-1-C

TEST	Overload	Visual Inspection	Electrical Characteristics		DPA
			Inductance μ H	Insul MOhm	
CONDITIONS	§5.13	§5.3	0,250V 100kHz N1	500V	§5.18
LIMITS			Max: 43,0		
			Min: 38,9	Min: 5000	
S/N: 096	✓	✓	40,2	✓	✓
S/N: 097	✓	✓	40,4	✓	
S/N: 098					
S/N: 099					
S/N: 100					

11.21 Q21 - ESCC320101301F14230080-2-C Pending

TEST	Solderability	Terminal Strength	Visual Inspection	Electrical Characteristics		Insulation Resistance	Visual Inspection	Dielectric Withstanding Voltage	
				Inductance μ H					Insul MOhm
CONDITIONS	§5.6	§5.8	§5.3	0,100V 125kHz NP1a NP1b		500V	§5.17	§5.3	§5.5 60s @ 300V
LIMITS				Max: 10,56	Max: 10,56				
				Min: 8,64	Min: 8,64	Min: 500			
S/N: 292	✓	✓	✓						
S/N: 296	✓	✓	✓						
S/N: 318	✓	✓	✓						
S/N: 319	✓	✓	✓						
S/N: 320	✓	✓	✓						

TEST	Electrical Characteristics		Mounting on PCB	Visual Inspection	Electrical Characteristics		Life	Dielectric Withstanding Voltage	
	Inductance μ H				Insul MOhm				
CONDITIONS	0,100V 125kHz NP1a NP1b			§5.3	0,100V 125kHz NP1a NP1b		500V	§5.15	§5.5 5s @ 225V
LIMITS	Max: 10,56	Max: 10,56			Max: 10,56	Max: 10,56			
	Min: 8,64	Min: 8,64	Min: 500		Min: 8,64	Min: 8,64	Min: 500		
S/N: 292									
S/N: 296									
S/N: 318									
S/N: 319									
S/N: 320									

Q21 – 14230080-2-C

TEST	Electrical Characteristics		Resistance to Solvents	Permanence of Marking	Vibration	Mechanical Shock	Visual Inspection	Electrical Characteristics		
	Inductance μ H	Insul MOhm						Inductance μ H	Insul MOhm	
CONDITIONS	0,100V 125kHz NP1a NP1b		500V	§5.7	§5.9	§5.10	§5.11	§5.3	0,100V 125kHz NP1a NP1b	500V
LIMITS	Max: 10,56	Max: 10,56							Max: 10,56	Max: 10,56
	Min: 8,64	Min: 8,64	Min: 500						Min: 8,64	Min: 8,64
S/N: 292										
S/N: 296										
S/N: 318										
S/N: 319										
S/N: 320										

TEST	Moisture Resistance	Electrical Characteristics		Winding Continuity	Thermal Shock	Electrical Characteristics		Partial Discharge	Temp Rise	
		Inductance μ H	Insul MOhm			Inductance μ H	Insul MOhm			
CONDITIONS	§5.12	0,100V 125kHz NP1a NP1b		500V	RD6	§5.4	0,100V 125kHz NP1a NP1b	500V	§5.16	§5.14
LIMITS		Max: 10,56	Max: 10,56				Max: 10,56	Max: 10,56		
		Min: 8,64	Min: 8,64	Min: 500			Min: 8,64	Min: 8,64	Min: 500	
S/N: 292										
S/N: 296										
S/N: 318										
S/N: 319										
S/N: 320										

Q21 – 14230080-2-C

TEST	Overload	Visual Inspection	Electrical Characteristics		DPA
			Inductance μ H		
CONDITIONS	§5.13	§5.3	0,100V 125kHz NP1a NP1b		500V §5.18
LIMITS			Max: 10,56	Max: 10,56	
			Min: 8,64	Min: 8,64	Min: 500
S/N: 292					
S/N: 296					
S/N: 318					
S/N: 319					
S/N: 320					

11.22 Q22 – 14890203-1-B

TEST	Solderability	Terminal Strength	Visual Inspection	Electrical Characteristics		Insulation Resistance	Visual Inspection	Dielectric Withstanding Voltage
				Inductance μH	Insul MOhm			
CONDITIONS	§5.6	§5.8	§5.3	0,250V 100kHz N1	500V	§5.17	§5.3	§5.5 60s @ 500V
LIMITS				Max: 242,9				
				Min: 145,8	Min: 5000			
S/N: 214	✓		✓	155	✓	✓	✓	✓
S/N: 215	✓		✓	159	✓	✓	✓	✓
S/N: 216	✓		✓	161	✓	✓	✓	✓
S/N: 217	✓		✓	159	✓	✓	✓	✓
S/N: 218	✓		✓	155	✓	✓	✓	✓

TEST	Electrical Characteristics		Mounting on PCB	Visual Inspection	Electrical Characteristics		Life	Dielectric Withstanding Voltage
	Inductance μH	Insul MOhm			Inductance μH	Insul MOhm		
CONDITIONS	0,250V 100kHz N1	500V		§5.3	0,250V 100kHz N1	500V	§5.15	§5.5 5s @ 375V
LIMITS	Max: 242,9				Max: 242,9			
	Min: 145,8	Min: 5000			Min: 145,8	Min: 5000		
S/N: 214	154	✓	✓	✓	152	✓		
S/N: 215	159	✓	✓	✓	158	✓		
S/N: 216	160	✓					✓	✓
S/N: 217	160	✓					✓	✓
S/N: 218	155	✓					✓	✓

Q22 – 14890203-1-B

TEST	Electrical Characteristics		Resistance to Solvents	Permanence of Marking	Vibration	Mechanical Shock	Visual Inspection	Electrical Characteristics	
	Inductance μ H	Insul MOhm						Inductance μ H	Insul MOhm
CONDITIONS	0,250V 100kHz N1	500V	§5.7	§5.9	§5.10	§5.11	§5.3	0,250V 100kHz N1	500V
LIMITS	Max: 242,9							Max: 242,9	
	Min: 145,8	Min: 5000						Min: 145,8	Min: 5000
S/N: 214					✓	✓	✓	155	✓
S/N: 215					✓	✓	✓	160	✓
S/N: 216	169	✓	✓	✓					
S/N: 217	169	✓	✓	✓					
S/N: 218	164	✓	✓	✓					

TEST	Moisture Resistance	Electrical Characteristics		Winding Continuity	Thermal Shock	Electrical Characteristics		Partial Discharge	Temp Rise
		Inductance μ H	Insul MOhm			Inductance μ H	Insul MOhm		
CONDITIONS	§5.12	0,250V 100kHz N1	500V	RD6	§5.4	0,250V 100kHz N1	500V	§5.16	§5.14
LIMITS		Max: 242,9				Max: 242,9			
		Min: 145,8	Min: 5000			Min: 145,8	Min: 5000		
S/N: 214	✓	154	✓	✓	✓	153	✓		
S/N: 215	✓	158	✓	✓	✓	156	✓		
S/N: 216									
S/N: 217									
S/N: 218									

Q22 – 14890203-1-B

TEST	Overload	Visual Inspection	Electrical Characteristics		DPA
			Inductance μ H	Insul MOhm	
CONDITIONS	§5.13	§5.3	0,250V 100kHz N1	500V	§5.18
LIMITS			Max: 242,9		
			Min: 145,8	Min: 5000	
S/N: 214	✓	✓	154	✓	✓
S/N: 215	✓	✓	155	✓	
S/N: 216					
S/N: 217					
S/N: 218					

11.23 Q23 – 12248004-1-B

TEST	Solderability	Terminal Strength	Visual Inspection	Electrical Characteristics			Insulation Resistance	Visual Inspection	Dielectric Withstanding Voltage	
				Inductance μ H						Insul MOhm
CONDITIONS	§5.6	§5.8	§5.3	0,025V 10kHz			500V	§5.17	§5.3	§5.5 60s @ 300V
LIMITS				N1a	N1b	N2	Min: 5000			
				Max: 119,4	Max: 119,4	Max: 51,4				
S/N: 001	✓		✓	110,5	110,8	48,3	✓	✓	✓	✓
S/N: 002	✓		✓	111,6	111,9	48,7	✓	✓	✓	✓
S/N: 003	✓		✓	110	110,3	48,2	✓	✓	✓	✓
S/N: 004	✓		✓	110,8	110,5	48,4	✓	✓	✓	✓
S/N: 005	✓		✓	110,7	111	48,5	✓	✓	✓	✓

TEST	Electrical Characteristics				Mounting on PCB	Visual Inspection	Electrical Characteristics				Life	Dielectric Withstanding Voltage
	Inductance μ H			Insul MOhm			Inductance μ H			Insul MOhm		
CONDITIONS	0,025V 10kHz			500V	§5.3	0,025V 10kHz			500V	§5.15	§5.5 5s @ 225V	
LIMITS	N1a	N1b	N2	Min: 5000		N1a	N1b	N2	Min: 5000			
	Max: 119,4	Max: 119,4	Max: 51,4		Max: 119,4	Max: 119,4	Max: 51,4					
S/N: 001	110,3	110,7	48,2	✓	✓	✓	110,2	110,6	48,1	✓		
S/N: 002	111,2	111,6	48,7	✓	✓	✓	110,9	111,5	48,7	✓		
S/N: 003	110	110	48,2							✓	✓	
S/N: 004	110,7	110,4	48,4							✓	✓	
S/N: 005	110,8	111,2	48,5							✓	✓	

Q23 – 12248004-1-B

TEST	Electrical Characteristics			Resistance to Solvents	Permanence of Marking	Vibration	Mechanical Shock	Visual Inspection	Electrical Characteristics			
	Inductance μ H		Insul MOhm						Inductance μ H		Insul MOhm	
CONDITIONS	0,025V 10kHz			500V	§5.7	§5.9	§5.10	§5.11	§5.3	0,025V 10kHz		500V
	N1a	N1b	N2							N1a	N1b	N2
LIMITS	Max: 119,4	Max: 119,4	Max: 51,4							Max: 119,4	Max: 119,4	Max: 51,4
	Min: 97,7	Min: 97,7	Min: 42,1	Min: 5000						Min: 97,7	Min: 97,7	Min: 42,1
S/N: 001							✓	✓	✓	110,1	110,4	48,2
S/N: 002							✓	✓	✓	111,2	111,3	48,8
S/N: 003	110,5	110,8	48,4	✓	✓	✓						
S/N: 004	111,5	111,1	48,7	✓	✓	✓						
S/N: 005	111,3	111,5	48,7	✓	✓	✓						

TEST	Moisture Resistance	Electrical Characteristics			Winding Continuity	Thermal Shock	Electrical Characteristics			Partial Discharge	
		Inductance μ H		Insul MOhm			Inductance μ H		Insul MOhm		
CONDITIONS	§5.12	0,025V 10kHz			500V	RD6	§5.4	0,025V 10kHz		500V	§5.16
		N1a	N1b	N2				N1a	N1b	N2	
LIMITS		Max: 119,4	Max: 119,4	Max: 51,4				Max: 119,4	Max: 119,4	Max: 51,4	
		Min: 97,7	Min: 97,7	Min: 42,1	Min: 5000			Min: 97,7	Min: 97,7	Min: 42,1	Min: 5000
S/N: 001	✓	110,2	110,8	48,1	✓	✓	✓	110,4	110,9	48,3	✓
S/N: 002	✓	111,2	112,1	48,6	✓	✓	✓	111,4	112,0	48,7	✓
S/N: 003											
S/N: 004											
S/N: 005											

Q23 – 12248004-1-B

TEST	Temp Rise	Overload	Visual Inspection	Electrical Characteristics			DPA	
				Inductance μ H		Insul MOhm		
CONDITIONS	§5.14	§5.13	§5.3	0,025V 10kHz			500V	§5.18
LIMITS				N1a	N1b	N2		
				Max: 119,4	Max: 119,4	Max: 51,4		
				Min: 97,7	Min: 97,7	Min: 42,1	Min: 5000	
S/N: 001		✓	✓	110,5	110,8	48,3	✓	✓
S/N: 002		✓	✓	111,3	111,8	48,7	✓	
S/N: 003								
S/N: 004								
S/N: 005								

11.24 Q24 – 14241039-1-P

TEST	Solderability	Terminal Strength	Visual Inspection	Electrical Characteristics								Insulation Resistance
				Inductance μ H							Insul MOhm	
CONDITIONS	§5.6	§5.8	§5.3	0,250V 100kHz							500V	§5.17
				N1	N5	N2	N3	N4	N6	N7		
LIMITS				Max: 83,4	Max: 537	Max: 71,0	Max: 71,0	Max: 96,7	Max: 7,89	Max: 17,76		
				Min: 72,5	Min: 467	Min: 61,7	Min: 61,7	Min: 84,0	Min: 6,86	Min: 15,43	Min: 5000	
S/N: 014	✓	✓	✓	77,9	499	68,7	68,7	93,5	7,7	17,25	✓	✓
S/N: 015	✓	✓	✓	77,7	499	68,6	68,6	93,4	7,83	17,24	✓	✓
S/N: 016	✓	✓	✓	77,7	498	68,6	68,5	93,2	7,79	17,21	✓	✓
S/N: 017	✓	✓	✓	77,6	497	68,4	68,4	93,1	7,64	17,16	✓	✓
S/N: 018	✓	✓	✓	77,5	497	68,5	68,5	93,3	7,83	17,16	✓	✓

TEST	Visual Inspection	Dielectric Withstanding Voltage	Electrical Characteristics							Mounting on PCB	Visual Inspection	
			Inductance μ H									Insul MOhm
CONDITIONS	§5.3	§5.5 60s @ 500V	0,250V 100kHz							500V		
			N1	N5	N2	N3	N4	N6	N7			
LIMITS			Max: 83,4	Max: 537	Max: 71,0	Max: 71,0	Max: 96,7	Max: 7,89	Max: 17,76			
			Min: 72,5	Min: 467	Min: 61,7	Min: 61,7	Min: 84,0	Min: 6,86	Min: 15,43	Min: 5000		
S/N: 014	✓	✓	77,9	499	68,7	68,7	93,5	7,7	17,25	✓	✓	
S/N: 015	✓	✓	77,7	499	68,6	68,6	93,4	7,83	17,24	✓	✓	
S/N: 016	✓	✓	77,7	498	68,6	68,5	93,2	7,79	17,21	✓		
S/N: 017	✓	✓	77,6	497	68,4	68,4	93,1	7,64	17,16	✓		
S/N: 018	✓	✓	77,5	497	68,5	68,5	93,3	7,83	17,16	✓		

Q24 – 14241039-1-P

TEST	Electrical Characteristics								Life Test	Dielectric Withstanding Voltage	Electrical Characteristics								
	Inductance μH										Insul MOhm	Inductance μH							
CONDITIONS	0,250V 100kHz								500V	§5.15		§5.5 5s @ 375V	0,250V 100kHz						
LIMITS	N1	N5	N2	N3	N4	N6	N7		Min: 5000			N1	N5	N2	N3	N4	N6	N7	
	Max: 83,4	Max: 537	Max: 71,0	Max: 71,0	Max: 96,7	Max: 7,89	Max: 17,76					Max: 83,4	Max: 537	Max: 71,0	Max: 71,0	Max: 96,7	Max: 7,89	Max: 17,76	
S/N: 014	77,8	501	68,6	68,8	93,4	7,71	17,26	✓											
S/N: 015	77,8	498	68,7	68,5	93,3	7,8	17,25	✓											
S/N: 016									✓	✓		77,8	501	68,7	68,5	93,3	7,81	17,21	
S/N: 017									✓	✓		77,7	498	68,4	68,5	93,2	7,67	17,18	
S/N: 018									✓	✓		77,6	497	68,6	68,5	93,2	7,81	17,18	

Q24 – 14241039-1-P

TEST	Electrical Characteristics	Resistance to Solvents	Permanence of Marking	Vibration	Mechanical Shock	Visual Inspection
	Insul MOhm					
CONDITIONS	500V	§5.7	§5.9	§5.10	§5.11	§5.3
LIMITS						
	Min: 5000					
S/N: 014				✓	✓	✓
S/N: 015				✓	✓	✓
S/N: 016	✓	✓	✓			
S/N: 017	✓	✓	✓			
S/N: 018	✓	✓	✓			

TEST	Electrical Characteristics								Moisture Resistance	Electrical Characteristics								
	Inductance µH							Insul MOhm		Inductance µH							Insul MOhm	
CONDITIONS	0,250V 100kHz								500V	§5.12	0,250V 100kHz							500V
	N1	N5	N2	N3	N4	N6	N7			N1	N5	N2	N3	N4	N6	N7		
LIMITS	Max: 83,4	Max: 537	Max: 71,0	Max: 71,0	Max: 96,7	Max: 7,89	Max: 17,76			Max: 83,4	Max: 537	Max: 71,0	Max: 71,0	Max: 96,7	Max: 7,89	Max: 17,76		
	Min: 72,5	Min: 467	Min: 61,7	Min: 61,7	Min: 84,0	Min: 6,86	Min: 15,43	Min: 5000		Min: 72,5	Min: 467	Min: 61,7	Min: 61,7	Min: 84,0	Min: 6,86	Min: 15,43	Min: 5000	
S/N: 014	77,4	499	68,5	68,8	92,4	7,71	17,26	✓	✓	77,9	503	68,8	69,8	93,4	7,73	17,27	✓	
S/N: 015	77,6	496	68,4	68,5	91,3	7,81	17,25	✓	✓	77,4	501	69,1	68,4	93,3	7,84	17,27	✓	
S/N: 016																		
S/N: 017																		
S/N: 018																		

Q24 – 14241039-1-P

TEST	Winding Continuity	Thermal Shock	Electrical Characteristics							Overload	Visual Inspection	
			Inductance μH									Insul MOhm
CONDITIONS	RD6	§5.4	0,250V 100kHz							500V	§5.13	§5.3
LIMITS			N1	N5	N2	N3	N4	N6	N7			
			Max: 83,4	Max: 537	Max: 71,0	Max: 71,0	Max: 96,7	Max: 7,89	Max: 17,76			
			Min: 72,5	Min: 467	Min: 61,7	Min: 61,7	Min: 84,0	Min: 6,86	Min: 15,43	Min: 5000		
S/N: 014	✓	✓	78,01	499	67,8	69,8	93,3	7,7	17,3	✓	✓	
S/N: 015	✓	✓	77,5	490	68,1	68,4	93,1	7,8	17,3	✓	✓	
S/N: 016												
S/N: 017												
S/N: 018												

TEST	Electrical Characteristics							DPA	
	Inductance μH								Insul MOhm
CONDITIONS	0,250V 100kHz							500V	§5.18
LIMITS	N1	N5	N2	N3	N4	N6	N7		
	Max: 83,4	Max: 537	Max: 71,0	Max: 71,0	Max: 96,7	Max: 7,89	Max: 17,76		
	Min: 72,5	Min: 467	Min: 61,7	Min: 61,7	Min: 84,0	Min: 6,86	Min: 15,43	Min: 5000	
S/N: 014	77,9	501	69,1	69,8	93,5	7,73	17,3	✓	
S/N: 015	77,5	496	69,4	68,4	93,2	7,84	17,3	✓	
S/N: 016									
S/N: 017									
S/N: 018									

11.25 Q25 – 12411058-1-P

TEST	Solderability	Terminal Strength	Visual Inspection	Electrical Characteristics		Insulation Resistance	Visual Inspection	Dielectric Withstanding Voltage
				Inductance μH	Insul MOhm			
CONDITIONS	§5.6	§5.8	§5.3	0,250V 100kHz N1	500V	§5.17	§5.3	§5.5 60s @ 500V
LIMITS				Max: 33,0				
				Min: 27,0	Min: 5000			
S/N: 001	N/A	N/A	N/A	30,6	✓	✓	✓	✓
S/N: 002	N/A	N/A	N/A	29,9	✓	✓	✓	✓
S/N: 003	N/A	N/A	N/A	30,5	✓	✓	✓	✓
S/N: 004	N/A	N/A	N/A	30,5	✓	✓	✓	✓
S/N: 005	N/A	N/A	N/A	30,4	✓	✓	✓	✓

TEST	Electrical Characteristics		Mounting on PCB	Visual Inspection	Electrical Characteristics		Life	Dielectric Withstanding Voltage
	Inductance μH	Insul MOhm			Inductance μH	Insul MOhm		
CONDITIONS	0,250V 100kHz N1	500V		§5.3	0,250V 100kHz N1	500V	§5.15	§5.5 5s @ 375V
LIMITS	Max: 33,0				Max: 33,0			
	Min: 27,0	Min: 5000			Min: 27,0	Min: 5000		
S/N: 001	30,8	✓	✓	✓	30,1			
S/N: 002	29,7	✓	✓	✓	29,8			
S/N: 003	30,4	✓					✓	✓
S/N: 004	30,3	✓					✓	✓
S/N: 005	30,3	✓					✓	✓

Q25 – 12411058-1-P

TEST	Electrical Characteristics		Resistance to Solvents	Permanence of Marking	Vibration	Mechanical Shock	Visual Inspection	Electrical Characteristics	
	Inductance μ H	Insul MOhm						Inductance μ H	Insul MOhm
CONDITIONS	0,250V 100kHz N1	500V	§5.7	§5.9	§5.10	§5.11	§5.3	0,250V 100kHz N1	500V
LIMITS	Max: 33,0							Max: 33,0	
	Min: 27,0	Min: 5000						Min: 27,0	Min: 5000
S/N: 001					✓	✓	✓	30,2	✓
S/N: 002					✓	✓	✓	29,9	✓
S/N: 003	30,4	✓	✓	✓					
S/N: 004	30,3	✓	✓	✓					
S/N: 005	30,3	✓	✓	✓					

TEST	Moisture Resistance	Electrical Characteristics		Winding Continuity	Thermal Shock	Electrical Characteristics		Partial Discharge	Temp Rise
		Inductance μ H	Insul MOhm			Inductance μ H	Insul MOhm		
CONDITIONS	§5.12	0,250V 100kHz N1	500V	RD6	§5.4	0,250V 100kHz N1	500V	§5.16	§5.14
LIMITS		Max: 33,0				Max: 33,0			
		Min: 27,0	Min: 5000			Min: 27,0	Min: 5000		
S/N: 001	✓	30,0	✓	✓	✓	30,1	✓		
S/N: 002	✓	29,9	✓	✓	✓	29,8	✓		
S/N: 003									
S/N: 004									
S/N: 005									

Q25 – 12411058-1-P

TEST	Overload	Visual Inspection	Electrical Characteristics		DPA
			Inductance μ H	Insul MOhm	
CONDITIONS	§5.13	§5.3	0,250V 100kHz N1	500V	§5.18
LIMITS			Max: 33,0		
			Min: 27,0	Min: 5000	
S/N: 001	✓	✓	30,1	✓	✓
S/N: 002	✓	✓	29,	✓	
S/N: 003					
S/N: 004					
S/N: 005					

11.26 Q26 – 12411057-1-P

TEST	Solderability	Terminal Strength	Visual Inspection	Electrical Characteristics		Insulation Resistance	Visual Inspection	Dielectric Withstanding Voltage
				Inductance μH	Insul MOhm			
CONDITIONS	§5.6	§5.8	§5.3	0,250V 100kHz N1	500V	§5.17	§5.3	§5.5 60s @ 500V
LIMITS				Max: 68,6				
				Min: 56,2	Min: 5000			
S/N: 001	N/A	N/A	N/A	62,1	✓	✓	✓	✓
S/N: 002	N/A	N/A	N/A	61,4	✓	✓	✓	✓
S/N: 003	N/A	N/A	N/A	62,2	✓	✓	✓	✓
S/N: 004	N/A	N/A	N/A	61,2	✓	✓	✓	✓
S/N: 005	N/A	N/A	N/A	61,7	✓	✓	✓	✓

TEST	Electrical Characteristics		Mounting on PCB	Visual Inspection	Electrical Characteristics		Life	Dielectric Withstanding Voltage
	Inductance μH	Insul MOhm			Inductance μH	Insul MOhm		
CONDITIONS	0,250V 100kHz N1	500V		§5.3	0,250V 100kHz N1	500V	§5.15	§5.5 5s @ 375V
LIMITS	Max: 68,6				Max: 68,6			
	Min: 56,2	Min: 5000			Min: 56,2	Min: 5000		
S/N: 001	62,4	✓	✓	✓	64,4	✓		
S/N: 002	61,9	✓	✓	✓	63,9	✓		
S/N: 003	63,5	✓					✓	✓
S/N: 004	60,6	✓					✓	✓
S/N: 005	61,9	✓					✓	✓

Q26 – 12411057-1-P

TEST	Electrical Characteristics		Resistance to Solvents	Permanence of Marking	Vibration	Mechanical Shock	Visual Inspection	Electrical Characteristics	
	Inductance μ H	Insul MOhm						Inductance μ H	Insul MOhm
CONDITIONS	0,250V 100kHz N1	500V	§5.7	§5.9	§5.10	§5.11	§5.3	0,250V 100kHz N1	500V
LIMITS	Max: 68,6							Max: 68,6	
	Min: 56,2	Min: 5000						Min: 56,2	Min: 5000
S/N: 001					✓	✓	✓	63,4	✓
S/N: 002					✓	✓	✓	62,8	✓
S/N: 003	63,6	✓	✓	✓					
S/N: 004	62,6	✓	✓	✓					
S/N: 005	63,9	✓	✓	✓					

TEST	Moisture Resistance	Electrical Characteristics		Winding Continuity	Thermal Shock	Electrical Characteristics		Partial Discharge	Temp Rise
		Inductance μ H	Insul MOhm			Inductance μ H	Insul MOhm		
CONDITIONS	§5.12	0,250V 100kHz N1	500V	RD6	§5.4	0,250V 100kHz N1	500V	§5.16	§5.14
LIMITS		Max: 68,6				Max: 68,6			
		Min: 56,2	Min: 5000			Min: 56,2	Min: 5000		
S/N: 001	✓	63,5	✓	✓	✓	63,4	✓		
S/N: 002	✓	62,7	✓	✓	✓	62,7	✓		
S/N: 003									
S/N: 004									
S/N: 005									

Q26 – 12411057-1-P

TEST	Overload	Visual Inspection	Electrical Characteristics		DPA
			Inductance μ H	Insul MOhm	
CONDITIONS	§5.13	§5.3	0,250V 100kHz N1	500V	§5.18
LIMITS			Max: 68,6		
			Min: 56,2	Min: 5000	
S/N: 001	✓	✓	63,2	✓	✓
S/N: 002	✓	✓	62,9	✓	
S/N: 003					
S/N: 004					
S/N: 005					

11.27 Q27 – 12141123-1-P

TEST	Solderability	Terminal Strength	Visual Inspection	Electrical Characteristics		Insulation Resistance	Visual Inspection	Dielectric Withstanding Voltage
				Inductance μH	Insul MOhm			
CONDITIONS	§5.6	§5.8	§5.3	0,250V 100kHz N1	500V	§5.17	§5.3	§5.5 60s @ 500V
LIMITS				Max: 14,37				
				Min: 11,76	Min: 5000			
S/N: 001	N/A	N/A	N/A	13,55	✓	✓	✓	✓
S/N: 002	N/A	N/A	N/A	13,92	✓	✓	✓	✓
S/N: 003	N/A	N/A	N/A	13,78	✓	✓	✓	✓
S/N: 004	N/A	N/A	N/A	13,79	✓	✓	✓	✓
S/N: 005	N/A	N/A	N/A	13,72	✓	✓	✓	✓

TEST	Electrical Characteristics		Mounting on PCB	Visual Inspection	Electrical Characteristics		Life	Dielectric Withstanding Voltage
	Inductance μH	Insul MOhm			Inductance μH	Insul MOhm		
CONDITIONS	0,250V 100kHz N1	500V		§5.3	0,250V 100kHz N1	500V	§5.15	§5.5 5s @ 375V
LIMITS	Max: 14,37				Max: 14,37			
	Min: 11,76	Min: 5000			Min: 11,76	Min: 5000		
S/N: 001	13,5	✓	✓	✓	13,7	✓		
S/N: 002	13,8	✓	✓	✓	13,5	✓		
S/N: 003	13,8	✓					✓	✓
S/N: 004	13,8	✓					✓	✓
S/N: 005	13,7	✓					✓	✓

Q27 – 12141123-1-P

TEST	Electrical Characteristics		Resistance to Solvents	Permanence of Marking	Vibration	Mechanical Shock	Visual Inspection	Electrical Characteristics	
	Inductance μ H	Insul MOhm						Inductance μ H	Insul MOhm
CONDITIONS	0,250V 100kHz N1	500V	§5.7	§5.9	§5.10	§5.11	§5.3	0,250V 100kHz N1	500V
LIMITS	Max: 14,37							Max: 14,37	
	Min: 11,76	Min: 5000						Min: 11,76	Min: 5000
S/N: 001					✓	✓	✓	13,9	✓
S/N: 002					✓	✓	✓	13,7	✓
S/N: 003	13,7	✓	✓	✓					
S/N: 004	13,8	✓	✓	✓					
S/N: 005	13,7	✓	✓	✓					

TEST	Moisture Resistance	Electrical Characteristics		Winding Continuity	Thermal Shock	Electrical Characteristics		Partial Discharge	Temp Rise
		Inductance μ H	Insul MOhm			Inductance μ H	Insul MOhm		
CONDITIONS	§5.12	0,250V 100kHz N1	500V	RD6	§5.4	0,250V 100kHz N1	500V	§5.16	§5.14
LIMITS		Max: 14,37				Max: 14,37			
		Min: 11,76	Min: 5000			Min: 11,76	Min: 5000		
S/N: 001	✓	13,8	✓	✓	✓	13,8	✓		
S/N: 002	✓	13,7	✓	✓	✓	13,8	✓		
S/N: 003									
S/N: 004									
S/N: 005									

Q27 – 12141123-1-P

TEST	Overload	Visual Inspection	Electrical Characteristics		DPA
			Inductance μ H	Insul MOhm	
CONDITIONS	§5.13	§5.3	0,250V 100kHz N1	500V	§5.18
LIMITS			Max: 14,37		
			Min: 11,76	Min: 5000	
S/N: 001	✓	✓	13,9	✓	✓
S/N: 002	✓	✓	13,9	✓	
S/N: 003					
S/N: 004					
S/N: 005					

11.28 Q28 – 12011044-1-P

TEST	Solderability	Terminal Strength	Visual Inspection	Electrical Characteristics		Insulation Resistance	Visual Inspection	Dielectric Withstanding Voltage
				Inductance μH	Insul MOhm			
CONDITIONS	§5.6	§5.8	§5.3	0,050V 100kHz N1	500V	§5.17	§5.3	§5.5 60s @ 500V
LIMITS				Max: 2,64				
				Min: 2,16	Min: 5000			
S/N: 001	N/A	N/A	N/A	2,55	✓	✓	✓	✓
S/N: 002	N/A	N/A	N/A	2,5	✓	✓	✓	✓
S/N: 003	N/A	N/A	N/A	2,47	✓	✓	✓	✓
S/N: 004	N/A	N/A	N/A	2,46	✓	✓	✓	✓
S/N: 005	N/A	N/A	N/A	2,55	✓	✓	✓	✓

TEST	Electrical Characteristics		Mounting on PCB	Visual Inspection	Electrical Characteristics		Life	Dielectric Withstanding Voltage
	Inductance μH	Insul MOhm			Inductance μH	Insul MOhm		
CONDITIONS	0,050V 100kHz N1	500V		§5.3	0,050V 100kHz N1	500V	§5.15	§5.5 5s @ 375V
LIMITS	Max: 2,64				Max: 2,64			
	Min: 2,16	Min: 5000			Min: 2,16	Min: 5000		
S/N: 001	2,5	✓	✓	✓	2,5	✓		
S/N: 002	2,6	✓	✓	✓	2,6	✓		
S/N: 003	2,5	✓					✓	✓
S/N: 004	2,4	✓					✓	✓
S/N: 005	2,5	✓					✓	✓

Q28 – 12011044-1-P

TEST	Electrical Characteristics		Resistance to Solvents	Permanence of Marking	Vibration	Mechanical Shock	Visual Inspection	Electrical Characteristics	
	Inductance μ H	Insul MOhm						Inductance μ H	Insul MOhm
CONDITIONS	0,050V 100kHz N1	500V	§5.7	§5.9	§5.10	§5.11	§5.3	0,050V 100kHz N1	500V
LIMITS	Max: 2,64							Max: 2,64	
	Min: 2,16	Min: 5000						Min: 2,16	Min: 5000
S/N: 001					✓	✓	✓	2,5	✓
S/N: 002					✓	✓	✓	2,5	✓
S/N: 003	2,4	✓	✓	✓					
S/N: 004	2,5	✓	✓	✓					
S/N: 005	2,5	✓	✓	✓					

TEST	Moisture Resistance	Electrical Characteristics		Winding Continuity	Thermal Shock	Electrical Characteristics		Partial Discharge	Temp Rise
		Inductance μ H	Insul MOhm			Inductance μ H	Insul MOhm		
CONDITIONS	§5.12	0,050V 100kHz N1	500V	RD6	§5.4	0,050V 100kHz N1	500V	§5.16	§5.14
LIMITS		Max: 2,64				Max: 2,64			
		Min: 2,16	Min: 5000			Min: 2,16	Min: 5000		
S/N: 001	✓	2,5	✓	✓	✓	2,5	✓		
S/N: 002	✓	2,5	✓	✓	✓	2,5	✓		
S/N: 003									
S/N: 004									
S/N: 005									

Q28 – 12011044-1-P

TEST	Overload	Visual Inspection	Electrical Characteristics		DPA
			Inductance μ H	Insul MOhm	
CONDITIONS	§5.13	§5.3	0,050V 100kHz N1	500V	§5.18
LIMITS			Max: 2,64		
			Min: 2,16	Min: 5000	
S/N: 001	✓	✓	2,4	✓	✓
S/N: 002	✓	✓	2,4	✓	
S/N: 003					
S/N: 004					
S/N: 005					

11.29 Q29 – 12939014-1-C

TEST	Solderability	Terminal Strength	Visual Inspection	Electrical Characteristics		Insulation Resistance	Visual Inspection	Dielectric Withstanding Voltage
				Inductance μ H	Insul MOhm			
CONDITIONS	§5.6	§5.8	§5.3	0,250V 30kHz N1a	500V	§5.17	§5.3	§5.5 60s @ 300V
LIMITS				Max: 518				
				Min: 424	Min: 5000			
S/N: 003	✓	✓	✓	470	✓	✓	✓	
S/N: 004	✓	✓	✓	473	✓	✓	✓	✓
S/N: 005	✓	✓	✓	469	✓	✓	✓	✓
S/N: 006	✓	✓	✓	470	✓	✓	✓	✓
S/N: 007	✓	✓	✓	470	✓	✓	✓	✓

TEST	Electrical Characteristics		Mounting on PCB	Visual Inspection	Electrical Characteristics		Life	Dielectric Withstanding Voltage
	Inductance μ H	Insul MOhm			Inductance μ H	Insul MOhm		
CONDITIONS	0,250V 30kHz N1a	500V		§5.3	0,250V 30kHz N1	500V	§5.15	§5.5 5s @ 255V
LIMITS	Max: 518				Max: 518			
	Min: 424	Min: 5000			Min: 424	Min: 5000		
S/N: 003	470	✓	✓	✓	482	✓		
S/N: 004	473	✓	✓	✓	490	✓		
S/N: 005	469	✓					✓	✓
S/N: 006	470	✓					✓	✓
S/N: 007	470	✓					✓	✓

Q29 – 12939014-1-C

TEST	Electrical Characteristics		Resistance to Solvents	Permanence of Marking	Vibration	Mechanical Shock	Visual Inspection	Electrical Characteristics	
	Inductance μ H	Insul MOhm						Inductance μ H	Insul MOhm
CONDITIONS	0,250V 30kHz N1a	500V	§5.7	§5.9	§5.10	§5.11	§5.3	0,250V 30kHz N1a	500V
LIMITS	Max: 518							Max: 518	
	Min: 424	Min: 5000						Min: 424	Min: 5000
S/N: 003					✓	✓	✓	485	✓
S/N: 004					✓	✓	✓	489	✓
S/N: 005	471	✓	✓	✓					
S/N: 006	480	✓	✓	✓					
S/N: 007	479	✓	✓	✓					

TEST	Moisture Resistance	Electrical Characteristics		Winding Continuity	Thermal Shock	Electrical Characteristics		Partial Discharge	Temp Rise
		Inductance μ H	Insul MOhm			Inductance μ H	Insul MOhm		
CONDITIONS	§5.12	0,250V 30kHz N1a	500V	RD6	§5.4	0,250V 30kHz N1a	500V	§5.16	§5.14
LIMITS		Max: 518				Max: 518			
		Min: 424	Min: 5000			Min: 424	Min: 5000		
S/N: 003	✓	488	✓	✓	✓	480	✓		
S/N: 004	✓	494	✓	✓	✓	487	✓		
S/N: 005									
S/N: 006									
S/N: 007									

Q29 – 12939014-1-C

TEST	Overload	Visual Inspection	Electrical Characteristics		DPA
			Inductance μ H	Insul MOhm	
CONDITIONS	§5.13	§5.3	0,250V 30kHz N1a	500V	§5.18
LIMITS			Max: 518		
			Min: 424	Min: 5000	
S/N: 003	✓	✓	482	✓	✓
S/N: 004	✓	✓	486	✓	
S/N: 005					
S/N: 006					
S/N: 007					

11.30 Q30 – 19210136-1-B

TEST	Solderability	Terminal Strength	Visual Inspection	Electrical Characteristics			Insulation Resistance	Visual Inspection	Dielectric Withstanding Voltage	
				Inductance μ H					Insul MOhm	Ind
CONDITIONS	§5.6	§5.8	§5.3	0,010V 10kHz			500V	§5.17	§5.3	§5.5 60s @ 300V
LIMITS				N1	N2	N3				
					Max: 14,08	Max: 251,5	Max: 1006			
				Min: 11,52	Min: 144,5	Min: 578	Min: 5000			
S/N: 009	N/A	N/A	N/A	13,33	205,9	821	✓	✓	✓	✓
S/N: 010	N/A	N/A	N/A	13,38	203,3	809	✓	✓	✓	✓
S/N: 011	N/A	N/A	N/A	13,38	215,4	857	✓	✓	✓	✓
S/N: 012	N/A	N/A	N/A	13,39	212,9	847	✓	✓	✓	✓
S/N: 013	N/A	N/A	N/A	13,32	206,8	823	✓	✓	✓	✓

TEST	Electrical Characteristics			Mounting on PCB	Visual Inspection	Electrical Characteristics			Life	Dielectric Withstanding Voltage		
	Inductance μ H					Insul MOhm	Inductance μ H			Insul MOhm	Ind	Trafo
CONDITIONS	0,010V 10kHz			500V		§5.3	0,010V 10kHz			500V	§5.15	§5.5 5s @ 225V
LIMITS	N1	N2	N3				N1	N2	N3			
		Max: 14,08	Max: 251,5	Max: 1006				Max: 14,08	Max: 251,5	Max: 1006		
	Min: 11,52	Min: 144,5	Min: 578	Min: 5000			Min: 11,52	Min: 144,5	Min: 578	Min: 5000		
S/N: 009	13,47	205,8	833	✓	✓	✓	13,5	206,1	838	✓		
S/N: 010	13,51	203,1	821	✓	✓	✓	13,4	203,2	818	✓		
S/N: 011	13,41	212,4	864	✓						✓	✓	✓
S/N: 012	13,44	214,6	856	✓						✓	✓	✓
S/N: 013	13,36	205,2	819	✓						✓	✓	✓

Q30 – 19210136-1-B

TEST	Electrical Characteristics				Resistance to Solvents	Permanence of Marking	Vibration	Mechanical Shock	Visual Inspection	Electrical Characteristics			
	Inductance μ H			Insul MOhm						Inductance μ H			Insul MOhm
CONDITIONS	0,010V 10kHz			500V	§5.7	§5.9	§5.10	§5.11	§5.3	0,010V 10kHz			500V
	N1	N2	N3							N1	N2	N3	
LIMITS	Max: 14,08	Max: 251,5	Max: 1006							Max: 14,08	Max: 251,5	Max: 1006	
	Min: 11,52	Min: 144,5	Min: 578	Min: 5000						Min: 11,52	Min: 144,5	Min: 578	Min: 5000
S/N: 009							✓	✓	✓	13,5	206,3	844	✓
S/N: 010							✓	✓	✓	13,4	203,1	821	✓
S/N: 011	13,54	211,2	866	✓	✓	✓							
S/N: 012	13,62	210,6	849	✓	✓	✓							
S/N: 013	13,48	206,4	818	✓	✓	✓							

TEST	Moisture Resistance	Electrical Characteristics				Winding Continuity		Thermal Shock	Electrical Characteristics				Partial Discharge
		Inductance μ H			Insul MOhm				Inductance μ H			Insul MOhm	
CONDITIONS	§5.12	0,010V 10kHz			500V	RD6		§5.4	0,010V 10kHz			500V	
		N1	N2	N3					N1	N2	N3		
LIMITS		Max: 14,08	Max: 251,5	Max: 1006		Ind	Trafo		Max: 14,08	Max: 251,5	Max: 1006		
		Min: 11,52	Min: 144,5	Min: 578	Min: 5000				Min: 11,52	Min: 144,5	Min: 578	Min: 5000	
S/N: 009	✓	13,5	206,3	844	✓	✓	✓	13,6	207,3	851	✓		
S/N: 010	✓	13,4	203,1	821	✓	✓	✓	13,5	204,2	823	✓		
S/N: 011													
S/N: 012													
S/N: 013													

Q30 – 19210136-1-B

TEST	Temp Rise	Overload	Visual Inspection	Electrical Characteristics			DPA
				Inductance μ H		Insul MOhm	
CONDITIONS	§5.14	§5.13	§5.3	0,010V 10kHz			§5.18
				N1	N2	N3	500V
LIMITS				Max: 14,08	Max: 251,5	Max: 1006	
				Min: 11,52	Min: 144,5	Min: 578	Min: 5000
S/N: 009		✓	✓	13,4	209	856	✓
S/N: 010		✓	✓	13,6	205	844	✓
S/N: 011							
S/N: 012							
S/N: 013							

11.31 Q31 – 14110323-1-B (CV10-2500) Pending

TEST	Solderability	Terminal Strength	Visual Inspection	Electrical Characteristics		Insulation Resistance	Visual Inspection	Dielectric Withstanding Voltage
				Inductance μ H	Insul MOhm			
CONDITIONS	§5.6	§5.8	§5.3	0,300V 100kHz N1	500V	§5.17	§5.3	§5.5 60s @ 300V
LIMITS				Max: 578				
				Min: 523	Min: 5000			
S/N:								
S/N:								
S/N:								
S/N:								
S/N:								
Date /Init								
Equipment								

TEST	Electrical Characteristics		Mounting on PCB	Visual Inspection	Electrical Characteristics		Life	Dielectric Withstanding Voltage
	Inductance μ H	Insul MOhm			Inductance μ H	Insul MOhm		
CONDITIONS	0,300V 100kHz N1	500V		§5.3	0,300V 100kHz N1	500V	§5.15	§5.5 5s @ 255V
LIMITS	Max: 578				Max: 578			
	Min: 523	Min: 5000			Min: 523	Min: 5000		
S/N:								
S/N:								
S/N:								
S/N:								
S/N:								
Date /Init								
Equipment								

Q31 – 14110323-1- B (CV10-2500)

TEST	Electrical Characteristics		Resistance to Solvents	Permanence of Marking	Vibration	Mechanical Shock	Visual Inspection	Electrical Characteristics	
	Inductance μ H	Insul MOhm						Inductance μ H	Insul MOhm
CONDITIONS	0,300V 100kHz N1	500V	§5.7	§5.9	§5.10	§5.11	§5.3	0,300V 100kHz N1	500V
LIMITS	Max: 578							Max: 578	
	Min: 523	Min: 5000						Min: 523	Min: 5000
S/N:									
S/N:									
S/N:									
S/N:									
S/N:									
Date /Init									
Equipment									

TEST	Moisture Resistance	Electrical Characteristics		Winding Continuity	Thermal Shock	Electrical Characteristics		Partial Discharge	Temp Rise
		Inductance μ H	Insul MOhm			Inductance μ H	Insul MOhm		
CONDITIONS	§5.12	0,300V 100kHz N1	500V	RD6	§5.4	0,300V 100kHz N1	500V	§5.16	§5.14
LIMITS		Max: 578				Max: 578			
		Min: 523	Min: 5000			Min: 523	Min: 5000		
S/N:									
S/N:									
S/N:									
S/N:									
S/N:									
Date /Init									
Equipment									

Q31 – 14110323-1- B (CV10-2500)

TEST	Overload	Visual Inspection	Electrical Characteristics		DPA
			Inductance μ H	Insul MOhm	
CONDITIONS	§5.13	§5.3	0,300V 100kHz N1	500V	§5.18
LIMITS			Max: 578		
			Min: 523	Min: 5000	
S/N:					
S/N:					
S/N:					
S/N:					
S/N:					
Date /Init					
Equipment					

11.32 Q32 – 14110323-1-B (Arathane 5750) Pending

TEST	Solderability	Terminal Strength	Visual Inspection	Electrical Characteristics		Insulation Resistance	Visual Inspection	Dielectric Withstanding Voltage
				Inductance μ H	Insul MOhm			
CONDITIONS	§5.6	§5.8	§5.3	0,300V 100kHz N1	500V	§5.17	§5.3	§5.5 60s @ 300V
LIMITS				Max: 578				
				Min: 523	Min: 5000			
S/N:								
S/N:								
S/N:								
S/N:								
S/N:								
Date /Init								
Equipment								

TEST	Electrical Characteristics		Mounting on PCB	Visual Inspection	Electrical Characteristics		Life	Dielectric Withstanding Voltage
	Inductance μ H	Insul MOhm			Inductance μ H	Insul MOhm		
CONDITIONS	0,300V 100kHz N1	500V		§5.3	0,300V 100kHz N1	500V	§5.15	§5.5 5s @ 255V
LIMITS	Max: 578				Max: 578			
	Min: 523	Min: 5000			Min: 523	Min: 5000		
S/N:								
S/N:								
S/N:								
S/N:								
S/N:								
Date /Init								
Equipment								

Q32 – 14110323-1-B (Arathane 5750)

TEST	Electrical Characteristics		Resistance to Solvents	Permanence of Marking	Vibration	Mechanical Shock	Visual Inspection	Electrical Characteristics	
	Inductance μ H	Insul MOhm						Inductance μ H	Insul MOhm
CONDITIONS	0,300V 100kHz N1	500V	§5.7	§5.9	§5.10	§5.11	§5.3	0,300V 100kHz N1	500V
LIMITS	Max: 578							Max: 578	
	Min: 523	Min: 5000						Min: 523	Min: 5000
S/N:									
S/N:									
S/N:									
S/N:									
S/N:									
Date /Init									
Equipment									

TEST	Moisture Resistance	Electrical Characteristics		Winding Continuity	Thermal Shock	Electrical Characteristics		Partial Discharge	Temp Rise
		Inductance μ H	Insul MOhm			Inductance μ H	Insul MOhm		
CONDITIONS	§5.12	0,300V 100kHz N1	500V	RD6	§5.4	0,300V 100kHz N1	500V	§5.16	§5.14
LIMITS		Max: 578				Max: 578			
		Min: 523	Min: 5000			Min: 523	Min: 5000		
S/N:									
S/N:									
S/N:									
S/N:									
S/N:									
Date /Init									
Equipment									

Q32 – 14110323-1-B (Arathane 5750)

TEST	Overload	Visual Inspection	Electrical Characteristics		DPA
			Inductance μ H	Insul MOhm	
CONDITIONS	§5.13	§5.3	0,300V 100kHz N1	500V	§5.18
LIMITS			Max: 578		
			Min: 523	Min: 5000	
S/N:					
S/N:					
S/N:					
S/N:					
S/N:					
Date /Init					
Equipment					

12. PARTS AND PART MOUNTING

12.1 Q1 - ESCC320101301F12009014-1

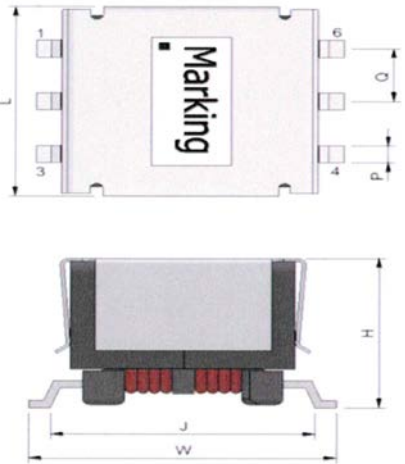
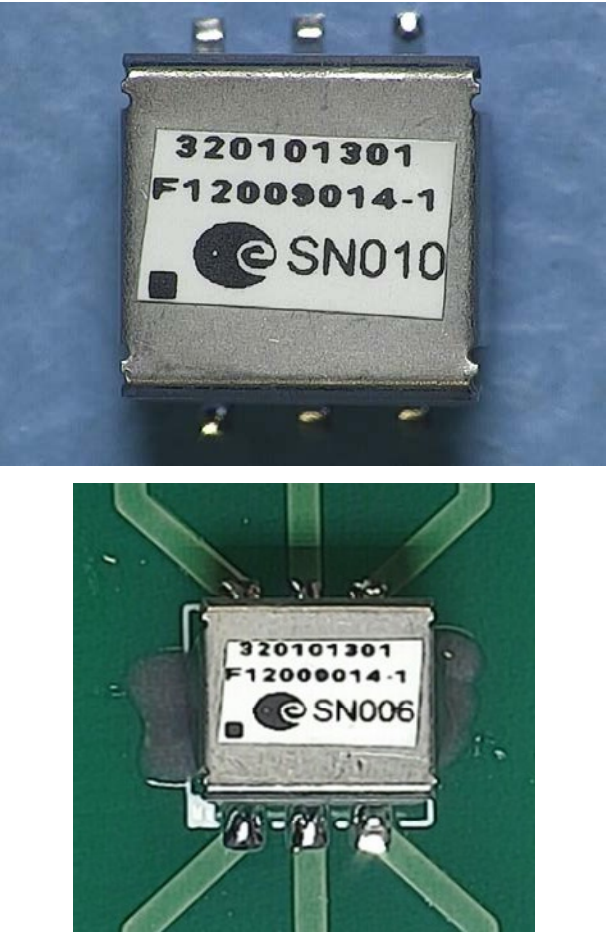
Part Outline	Part Mounting	Part Details
 <p>Technical drawing of the part showing top and side views with dimensions L, H, J, W, 1, 2, 3, 4, 5, 6, O, P.</p>	 <p>Photograph of the part mounted on a blue surface and a photograph of the part mounted on a green PCB.</p>	<ul style="list-style-type: none"> • Magnetics sheet 05000516-1 • ESCC320101301F12009014-1 • EP5 2K Coupled Inductor • 3C96 Core • SMT • Passive Life Test (120°C) • 500G Mechanical Shock • Random Vibration

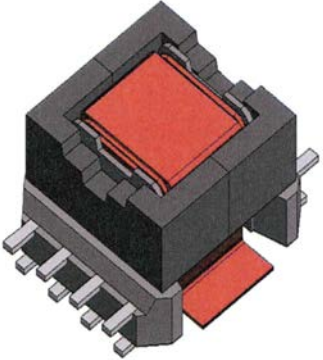
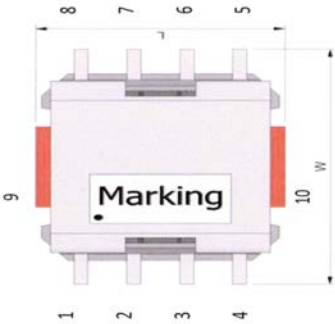
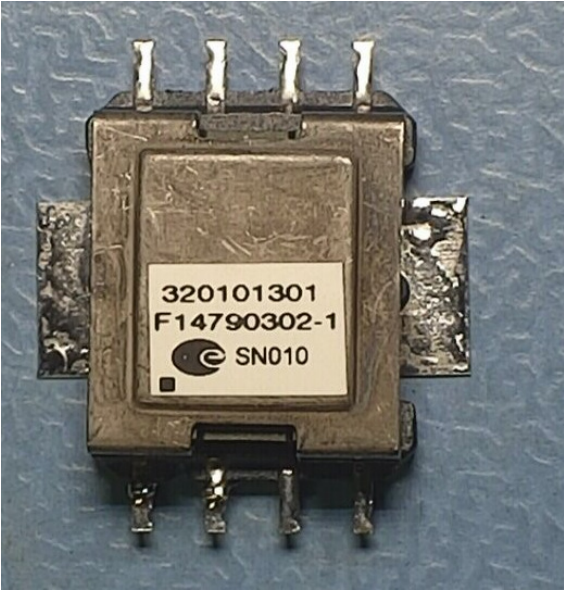

12.2 Q2 – ESCC320101301F14790302-1 pending

Part Outline	Part Mounting	Comments
  <p>Dimensions: 8, 7, 6, 5, 9, 10, W, 1, 2, 3, 4</p> <p>Marking</p>		<ul style="list-style-type: none"> • Magnetics sheet 05000530-1 • ESCC320101301F14790302-1 • SMD Current Sense • 3C96 Core • SMD • Passive Life Test (120°C) • 500G Mechanical Shock • Random Vibration

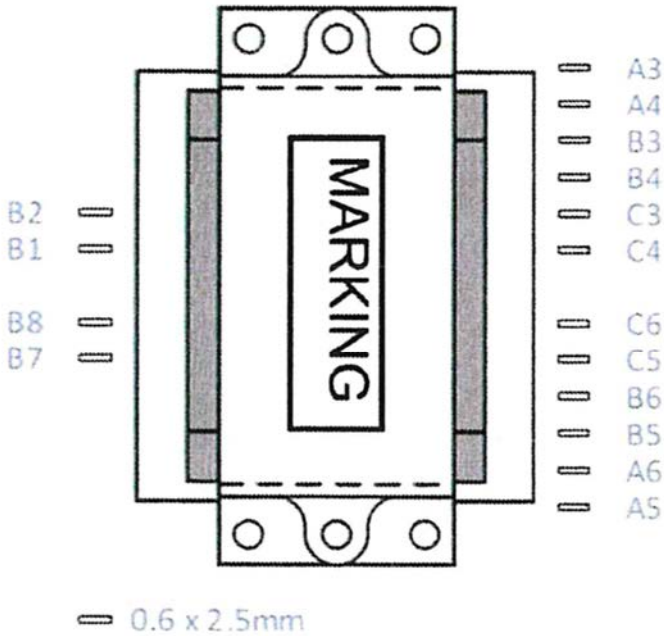
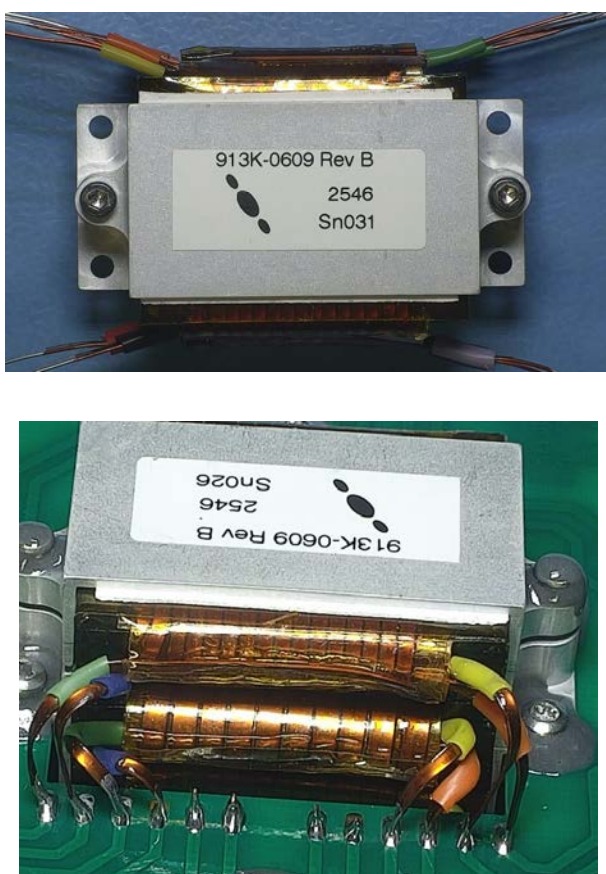
12.3 Q3 – 14391017-1-B

Part Outline	Part Mounting	Comments
 <p>Part Outline diagram showing a rectangular component with a central 'MARKING' area. The component has 12 pins labeled A3 through C4. The pin dimensions are 0.6 x 2.5mm.</p>	 <p>Two photographs of the component. The top photo shows the component mounted on a blue PCB with a label '913K-0609 Rev B 2546 Sn031'. The bottom photo shows the component mounted on a green PCB with a label '913K-0609 Rev B 2546 Sn026'.</p>	<p>Comments</p> <ul style="list-style-type: none"> • SCD 913X-0609 • 14391017-1-B • I3M 21.1 x 32 x 24 • Core PC95 • Pins • Active Life Test (85°C) • 500G Mechanical Shock • Random Vibration

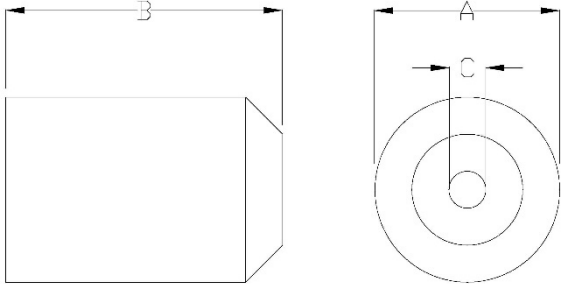
12.4 Q4 - 12000096-1-B

Part Outline	Part Mounting	Comments
	 	<ul style="list-style-type: none"> • SCD 924X-0007 • 12000096-1-B • Amobead Spikekiller • Core AB 3-2-3W • SMT • Passive Life Test (120°C) • 500G Mechanical Shock • Random Vibration

12.5 Q5 - ESCC320101301F14809024-1

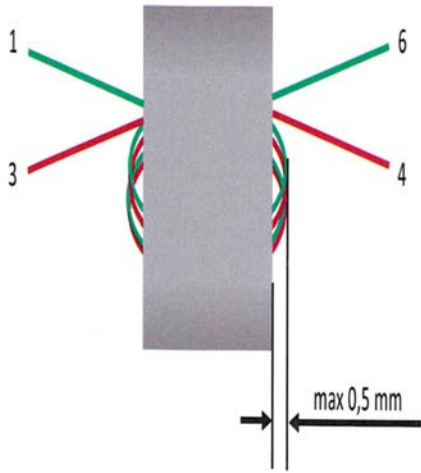
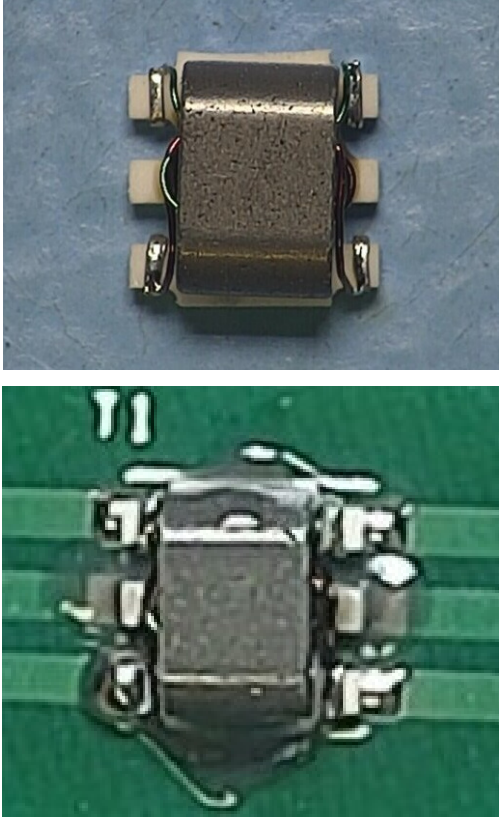
Part Outline	Part Mounting	Comments
		<ul style="list-style-type: none"> • Magnetics sheet 05000513-1 • ESCC320101301F14809024-1 • RF Transformer • Core Micrometals • SMD • Passive Life Test (120°C) • 500G Mechanical Shock • Random Vibration

12.6 Q6 - 14229012-1-P

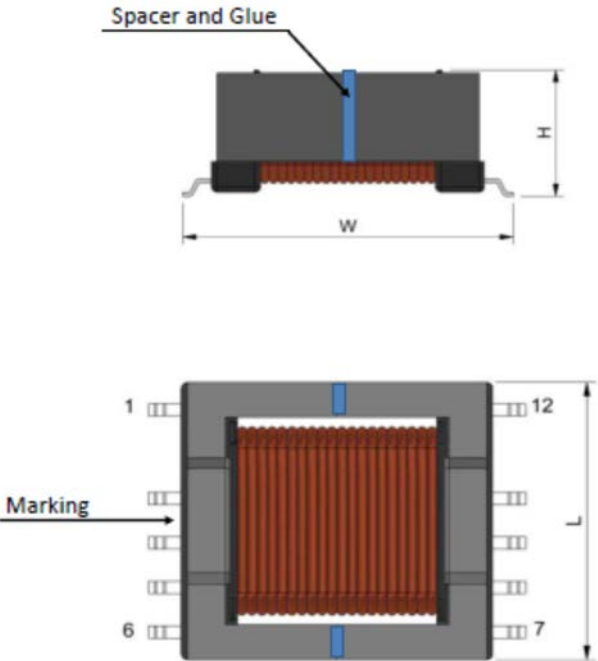
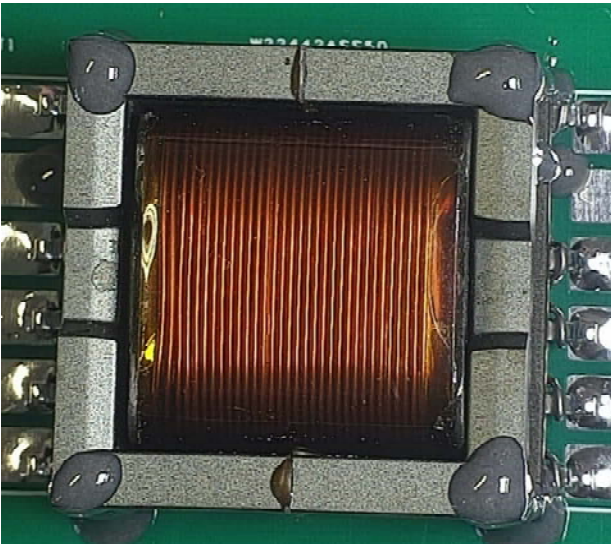
Part Outline	Part Mounting	Comments
<p data-bbox="353 236 517 261">Part Outline</p> 	<p data-bbox="1115 236 1310 261">Part Mounting</p> 	<p data-bbox="1809 236 1957 261">Comments</p> <ul data-bbox="1697 284 2007 491" style="list-style-type: none"> • MAG Sheet 0500515-1 • 14229012-1-P • 1:20 HV TRSF • Core EFD25 EC95 • SMT • Active Life Test (85°C) • 500G Mechanical Shock • Random Vibration

12.7 Q7 – Not used

Part Outline	Part Mounting	Comments

12.8 Q8 - ESCC320101301F14121040-1

Part Outline

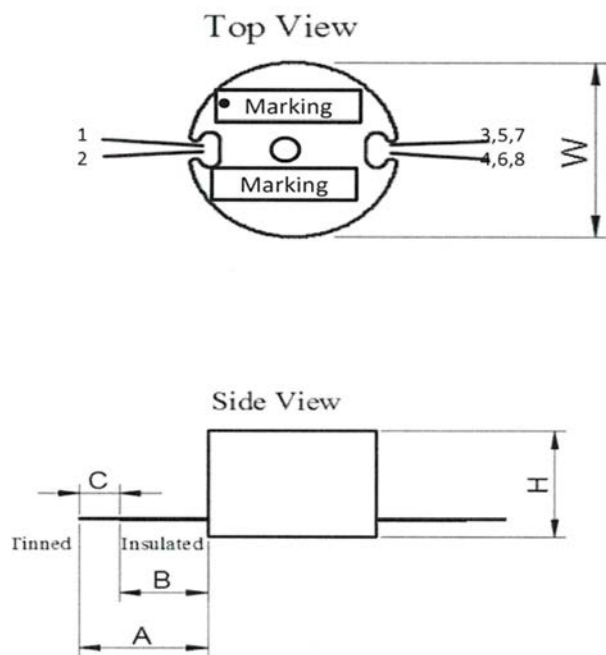



Part Mounting



Comments

- Magnetics sheet 05000517-1
- ESCC320101301F14121040-1
- 20W 63V Transformer
- Core P14/8 3F3
- Flying Leads
- Active Life Test (85°C)
- 500G Mechanical Shock
- Random Vibration

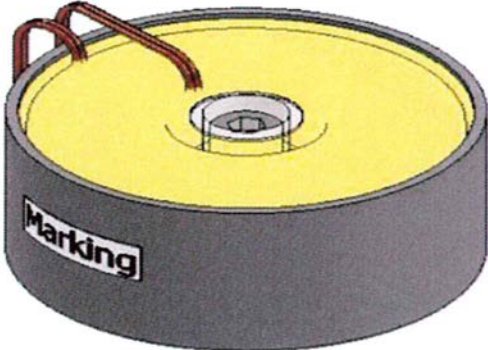
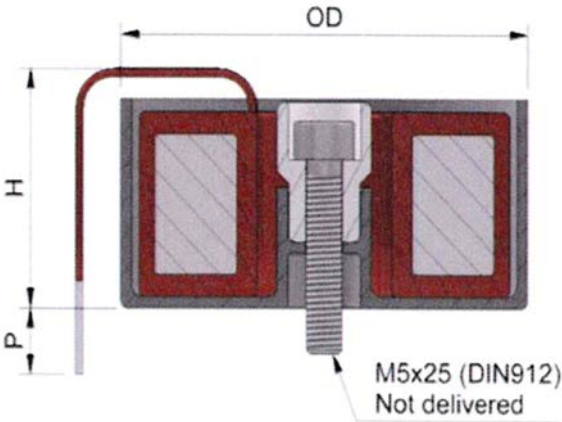
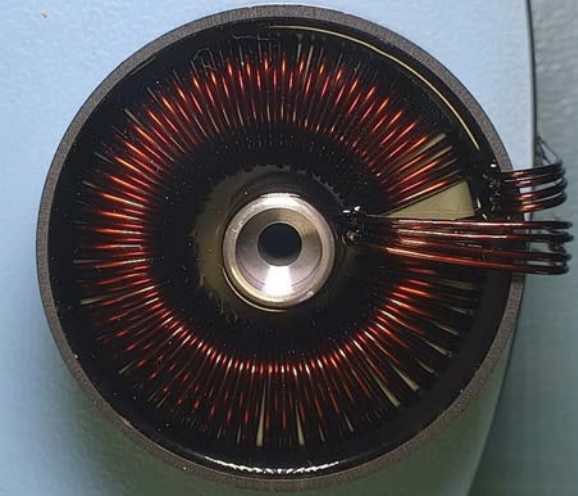
12.9 Q9 - 12385000-1-B

Part Outline	Part Mounting	Comments
 	 	<p>Comments</p> <ul style="list-style-type: none"> • FT 04980758-3 • 12385000-1-B • Buck Inductor • Core HF58439-A2 • Fixing Bolt / Flying leads • Passive Life Test (120°C) • 500G Mechanical Shock • Random Vibration

12.10 Q10 - ESCC320101301F14179033-1-C

Part Outline

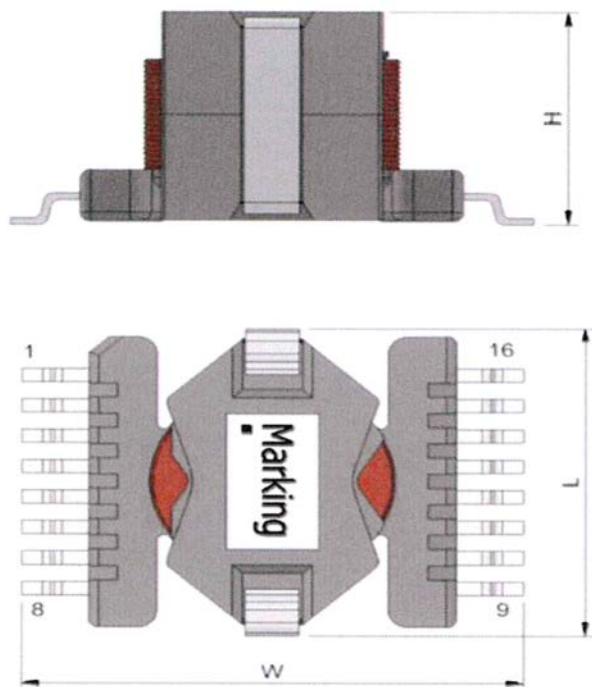

Part Mounting

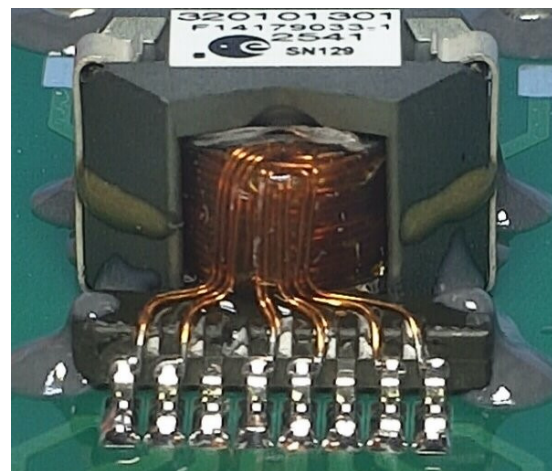
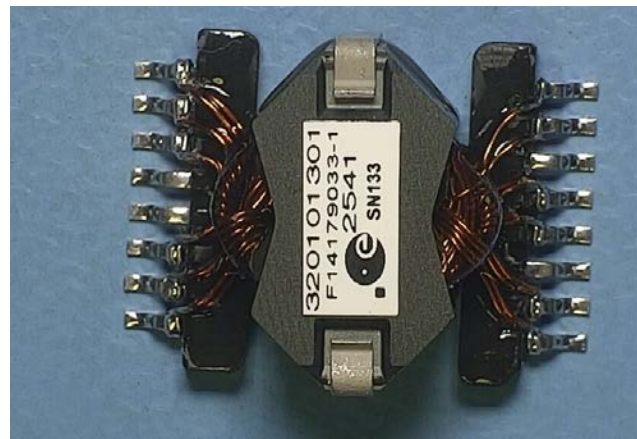

Comments

- Magnetics sheet 05000518-1
- ESCC320101301F14179033-1
- Flyback Transformer
- Core RM6 3F36
- SMT
- Active Life Test (85°C)
- 500G Mechanical Shock
- Random Vibration

12.11 Q11 – 12251055-1-B

Part Outline

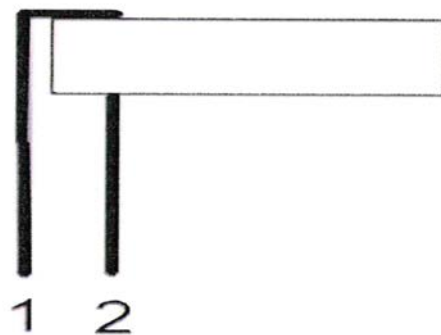

Part Mounting





Comments

- FT 04980945-1
- 12251055-1-B
- Power Inductor
- Magnetics Edge 59350
- Flying Leads
- Passive Life Test (120°C)
- 500G Mechanical Shock
- Random Vibration

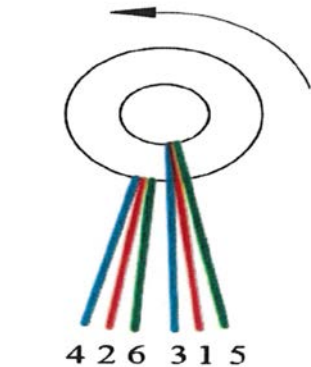
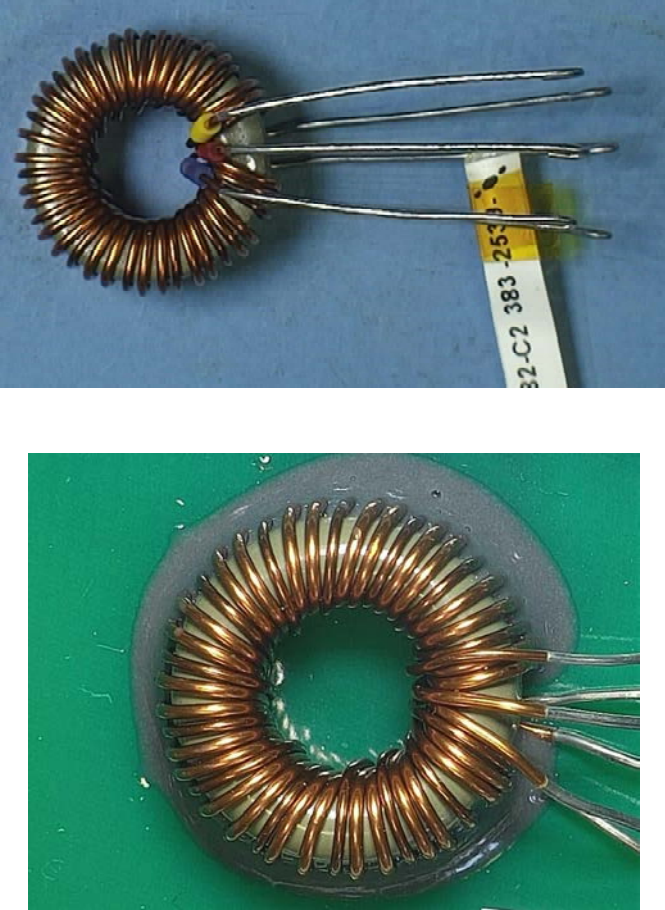
12.12 Q12 - 12141076-3-B

Part Outline	Part Mounting	Comments
<p data-bbox="320 347 618 379">Winding direction</p> 		<ul data-bbox="1697 284 2018 464" style="list-style-type: none"> • FT 07526112-3 • 12141076-3-B • Input Inductor • Hi Flux • Passive Life Test (120°C) • 500G Mechanical Shock • Random Vibration

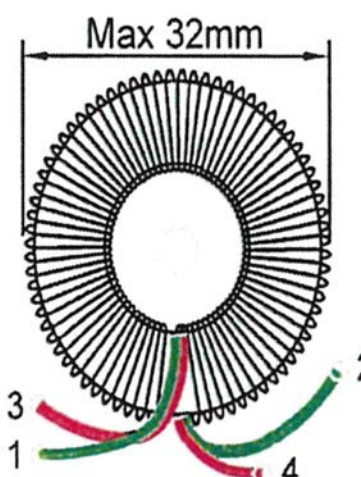
12.13 Q13 - 12311081-1-B

Part Outline	Part Mounting	Comments
 <p>Max 32mm</p>	 	<ul style="list-style-type: none"> • FT • 12311081-1-B • Super Buck Inductor • Hi Flux • Passive Life Test (120°C) • 500G Mechanical Shock • Random Vibration

12.14 Q14 - 12011041-1-B

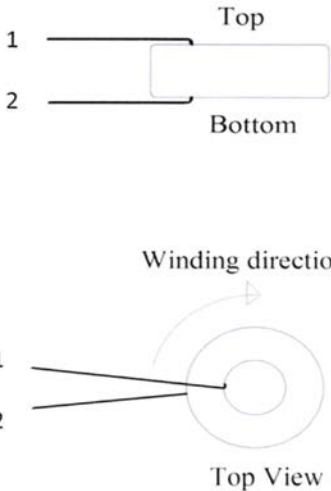
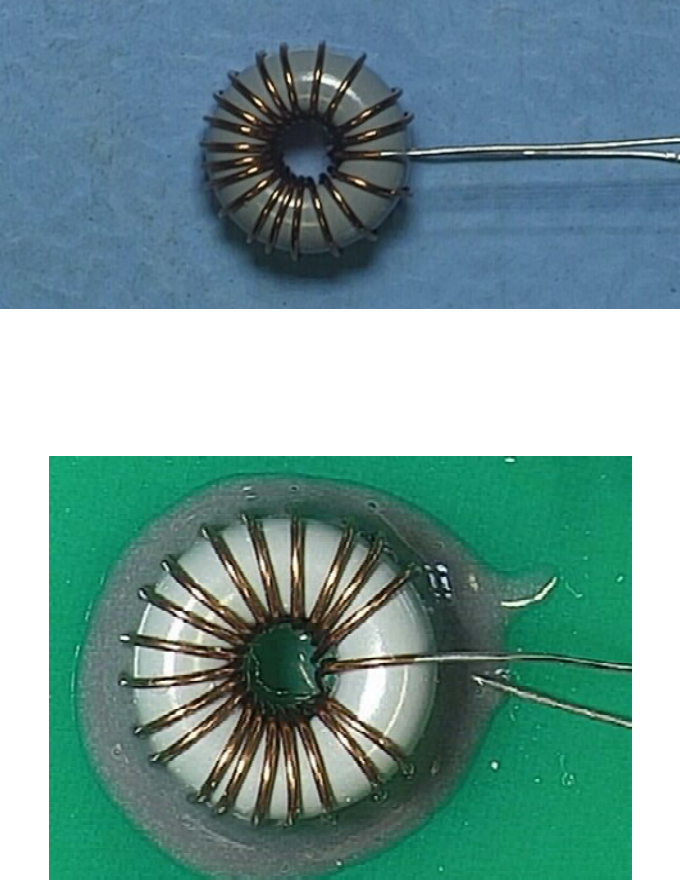
Part Outline	Part Mounting	Comments
 <p>The 'Part Outline' section contains two diagrams. The first is a side view of a rectangular component with two leads, labeled '1' and '2'. The top and bottom surfaces are indicated. The second diagram is a top view showing the circular core with two leads, labeled '1' and '2', and an arrow indicating the 'Winding direction'.</p>	 <p>The 'Part Mounting' section contains two photographs. The top photograph shows the component being held by tweezers against a blue background. The bottom photograph shows the component mounted on a green PCB, with the leads soldered to pads.</p>	<p>Comments</p> <ul style="list-style-type: none"> • FT 07528424-1 • 12011041-1-B • APR Aux Input Filter Inductor • Core MPP • Passive Life Test (120°C) • 500G Mechanical Shock • Random Vibration

12.15 Q15 – 14110319-1-B

Part Outline

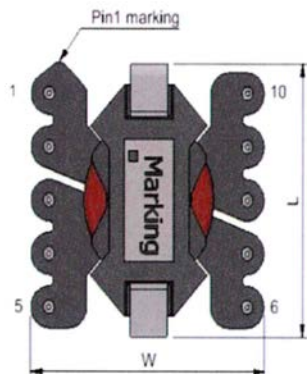

Part Mounting

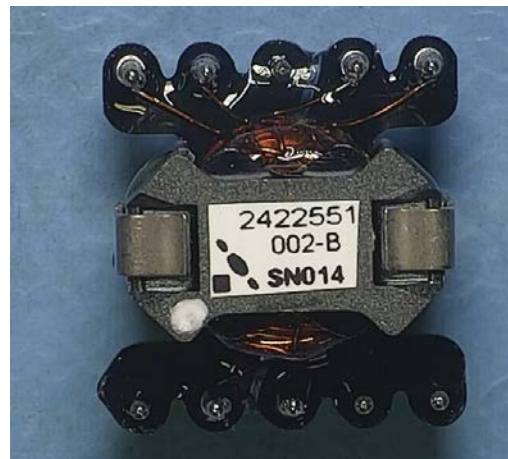

Comments

- 2422551-PD-B
- 14110319-1-B
- BCR Gate Drive Transformer
- RM4 T38
- Life Test
- 500G Mechanical Shock
- Random Vibration

12.16 Q16 - 14170338-2-B

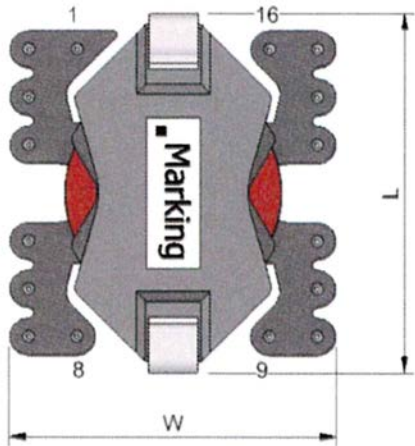
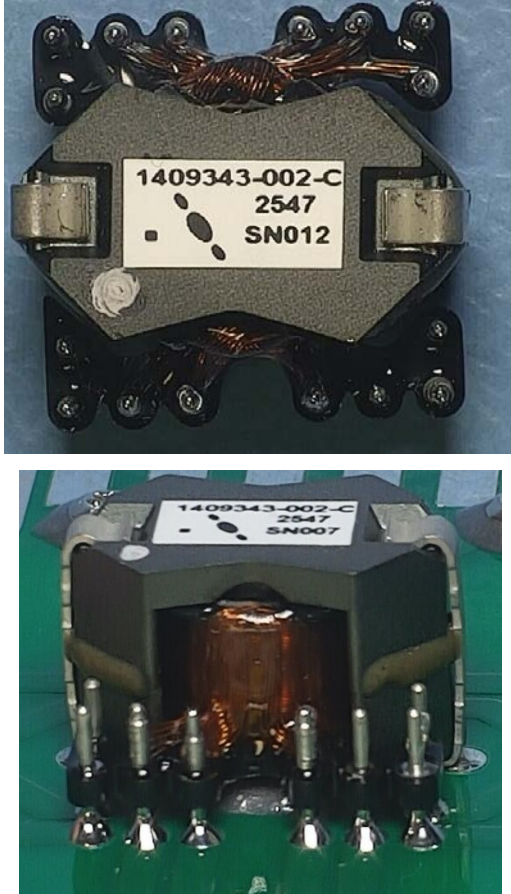
Part Outline	Part Mounting	Comments
		<p>Comments</p> <ul style="list-style-type: none"> • 1409343-PD Rev C • 14170338-2-B • FEE DIG Aux Supply Transformer • RM6 3C95 • Active Life Test (85°C) • 500G Mechanical Shock • Random Vibration

12.17 Q17 – 14220171-1-B

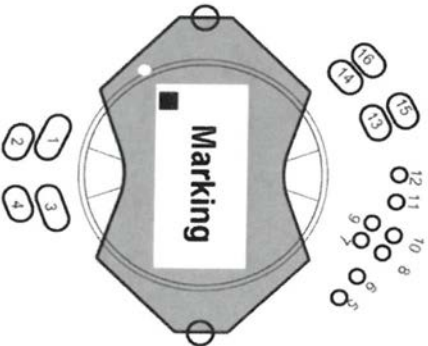
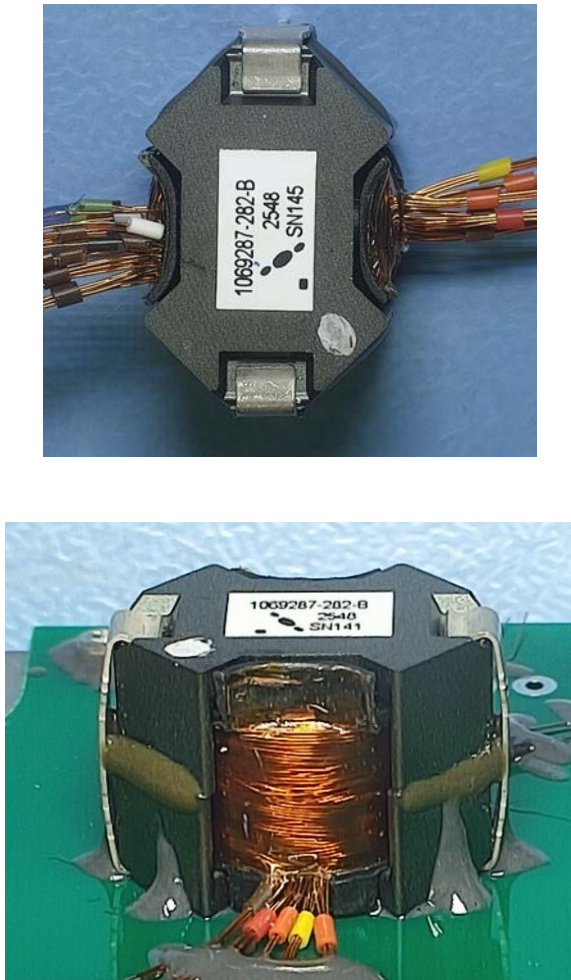
Part Outline	Part Mounting	Comments
		<ul style="list-style-type: none"> • 1069287-PD rev B2 • 14220171-1-B • Aux Supply Transformer • RM8 3C92 • Life Test • 500G Mechanical Shock • Random Vibration

12.18 Q18 - ESCC320101301F12180007-2-C

Part Outline

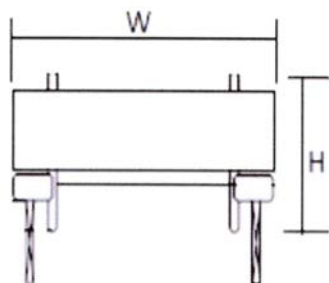
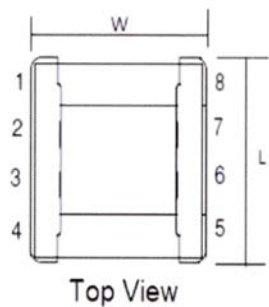

Part Mounting

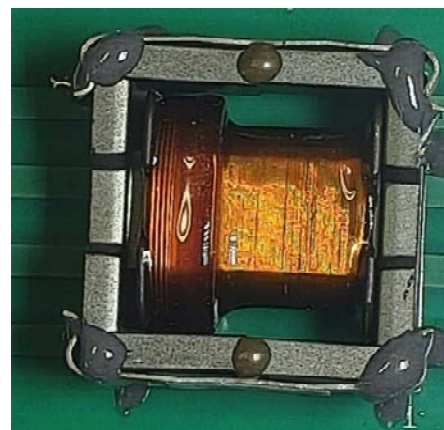
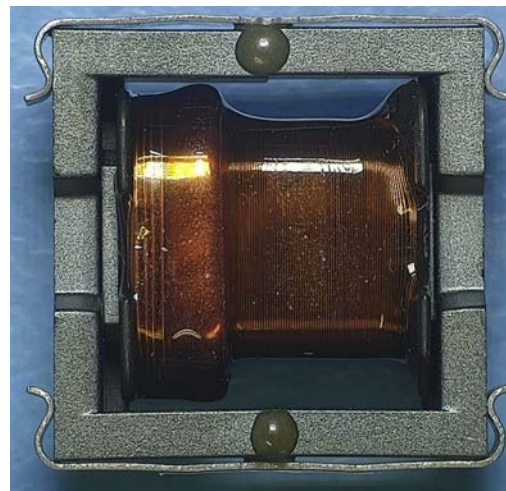

Comments

- Magnetics sheet 05000190-3
- ESCC320101301F12180007-2-C
- 5 μ H Inductor with Slave winding
- EFD20 3F3
- Passive Life Test (120°C)
- 500G Mechanical Shock
- Random Vibration
- Verification of relife process

12.19 Q19 - ESCC320101301F12011018-*-C

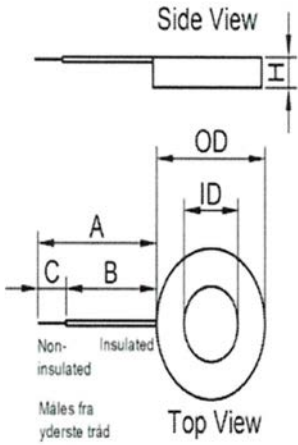
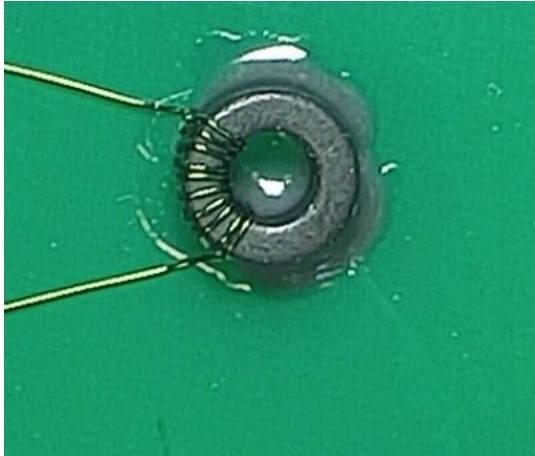
Part Outline	Part Mounting	Comments
<p style="text-align: center;">Part Outline</p> 	<p style="text-align: center;">Part Mounting</p> 	<p style="text-align: center;">Comments</p> <ul style="list-style-type: none"> • Magnetics sheet 05000008-* • ESCC320101301F12011018-*-C • Choke 10 Turns • 11-540-G (new supplier) • Passive Life Test (120°C) • 500G Mechanical Shock • Random Vibration

12.20 Q20 - ESCC320101301F14110308-1-C

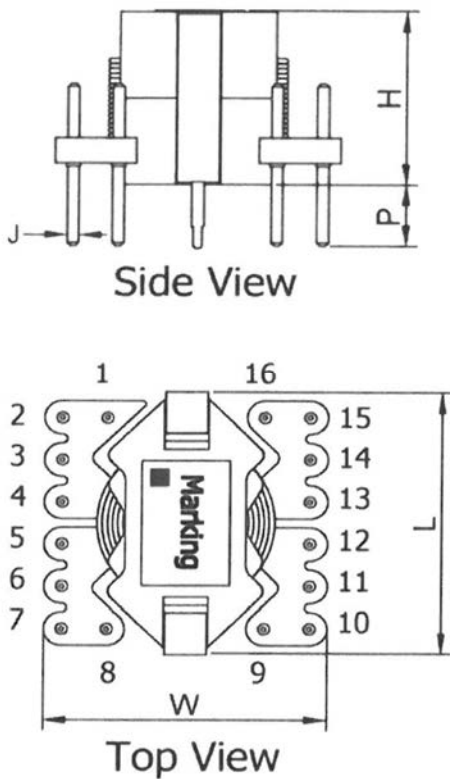
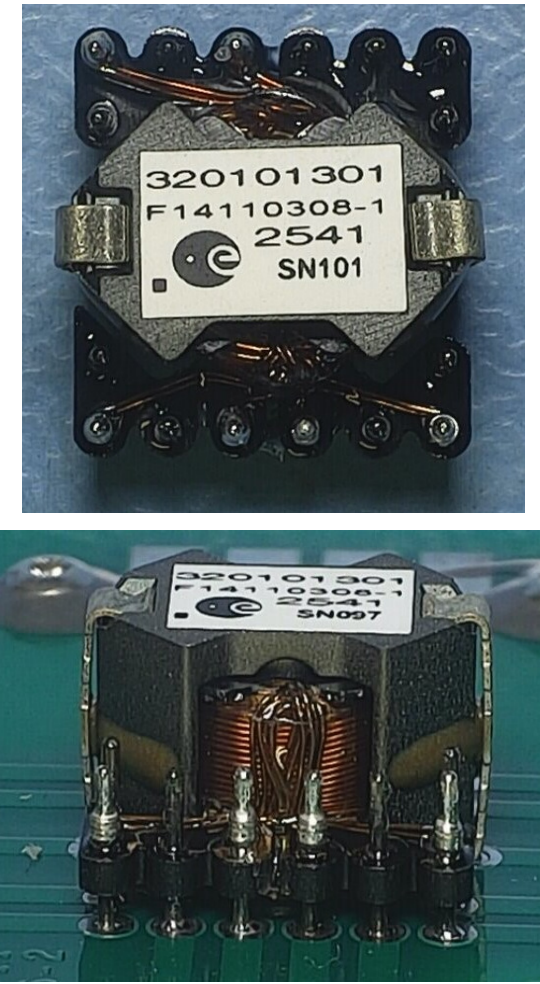
Part Outline	Part Mounting	Comments
<p style="text-align: center;">Part Outline</p>  <p style="text-align: center;">Side View</p> <p style="text-align: center;">Top View</p>	<p style="text-align: center;">Part Mounting</p> 	<p style="text-align: center;">Comments</p> <ul style="list-style-type: none"> • Magnetics sheet 05000282-1 • ESCC320101301F14110308-1-C • Transformer • RM5 3C95 • Passive Life Test (120°C) • 500G Mechanical Shock • Random Vibration

12.21 Q21 - ESCC320101301F14230080-2-C Pending

Part Outline

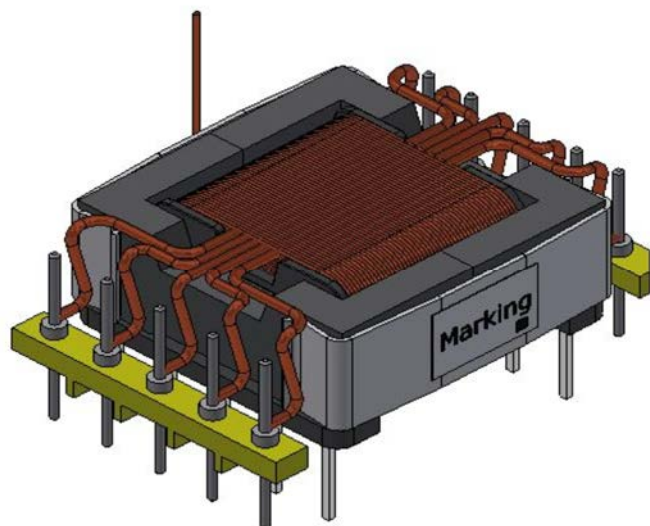

Part Mounting

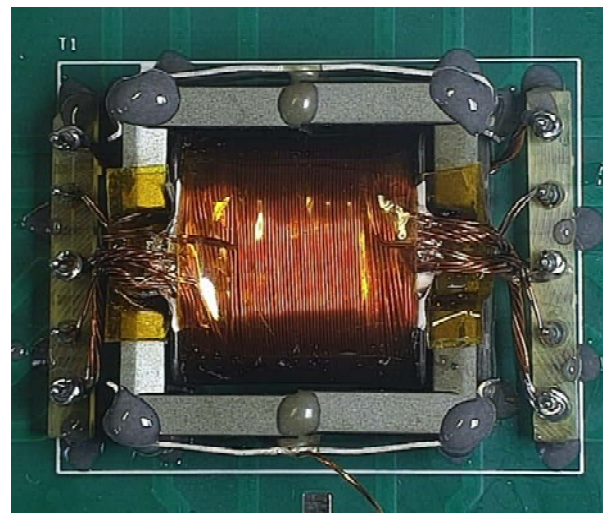
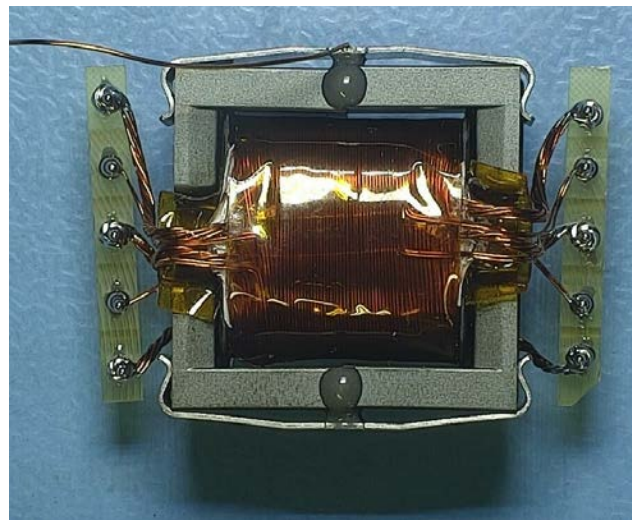

Comments

- Magnetics sheet 05000413-3
- ESCC320101301F14230080-2-C
- Transformer
- EFD25 N87
- Passive Life Test (120°C)
- 500G Mechanical Shock
- Random Vibration

12.22 Q22 - ESCC320101301F14890203-1-C

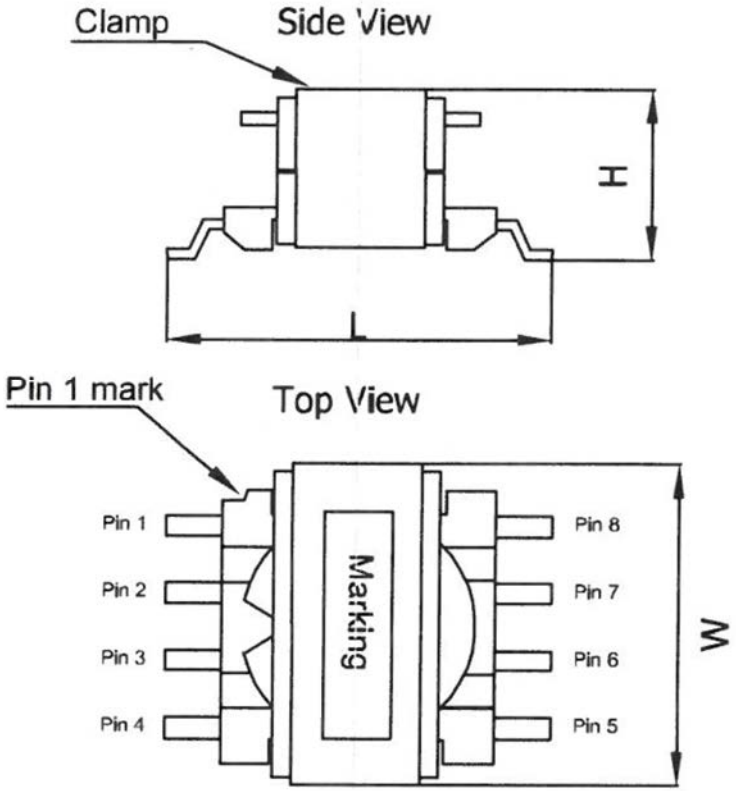
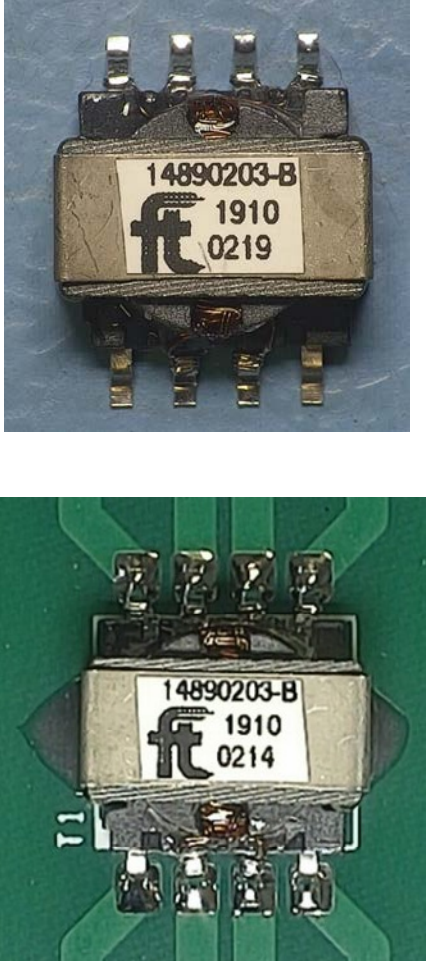
Part Outline	Part Mounting	Comments
<p style="text-align: center;">Part Outline</p> 	<p style="text-align: center;">Part Mounting</p> 	<p style="text-align: center;">Comments</p> <ul style="list-style-type: none"> • Magnetics sheet 05000039-1 • ESCC320101301F14890203-1-C • Gate Transformer • ER9.5 3C95 • Passive Life Test (120°C) • 500G Mechanical Shock • Random Vibration

12.23 Q23 – 12248004-1-B

Part Outline

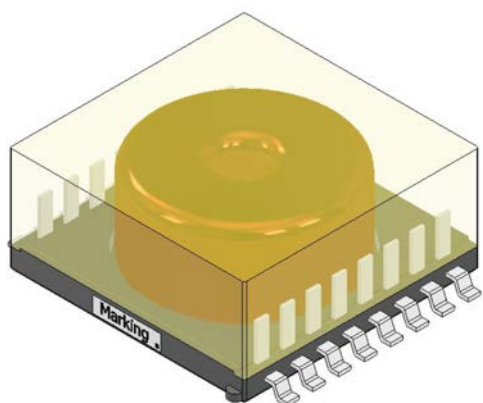

Part Mounting

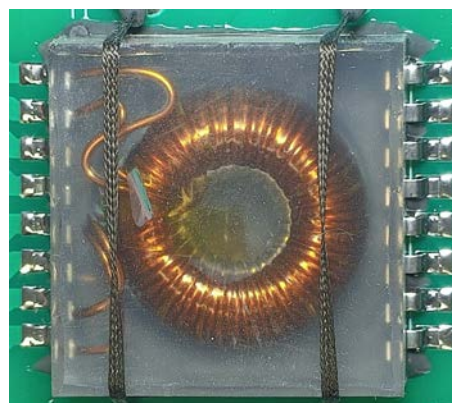
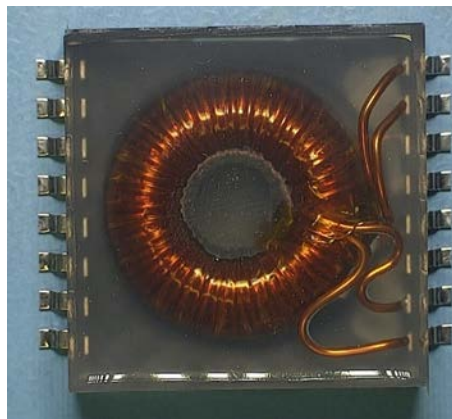

Comments

- FT 04980899-3-1
- 12248004-1-B
- Coupled Inductor 108 μ H
- MPP 55309
- Passive Life Test (120 $^{\circ}$ C)
- 500G Mechanical Shock
- Random Vibration

12.24 Q24 – 14241039-1-P

Part Outline

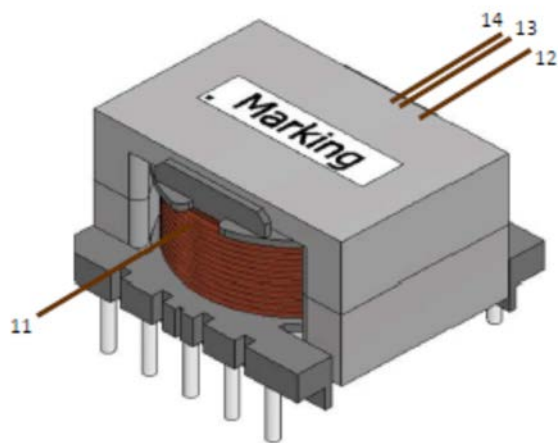

Part Mounting



Comments

- Magnetics Sheet 05000455-1
- 14241039-1-P
- EQ30 Transformer
- EQ30 3C95
- Active Life Test (85°C)
- 500G Mechanical Shock
- Random Vibration

12.25 Q25 – 12411058-1-P

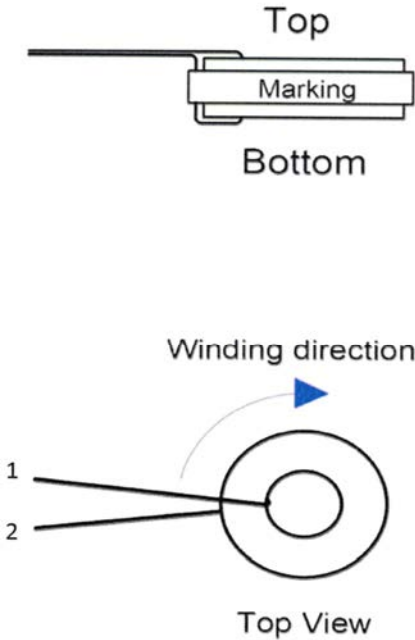
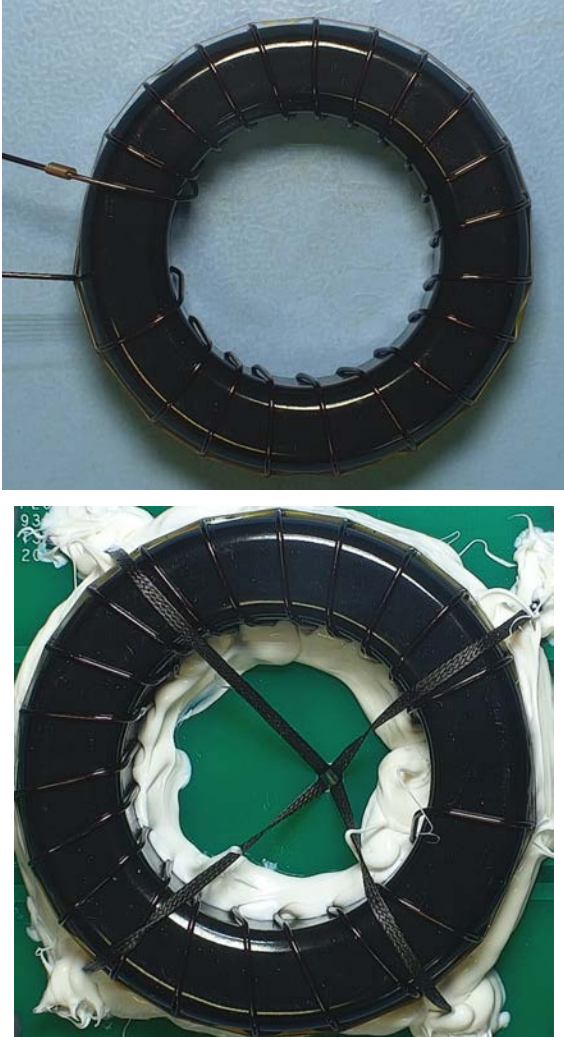
Part Outline	Part Mounting	Comments
<p data-bbox="383 236 544 264">Part Outline</p>  <p data-bbox="490 352 562 392">Top</p> <p data-bbox="490 424 589 453">Marking</p> <p data-bbox="472 496 602 531">Bottom</p> <p data-bbox="394 687 647 716">Winding direction</p> <p data-bbox="232 810 250 831">1</p> <p data-bbox="232 874 250 895">2</p> <p data-bbox="465 963 607 992">Top View</p>	<p data-bbox="1151 236 1339 264">Part Mounting</p> 	<p data-bbox="1809 236 1957 264">Comments</p> <ul data-bbox="1697 284 2018 464" style="list-style-type: none"> • FT 04980949-1 • 12411058-1-P • Inductor • Kool Mμ 70110 • Passive Life Test (120°C) • 500G Mechanical Shock • Random Vibration

12.26 Q26 – 12411057-1-P

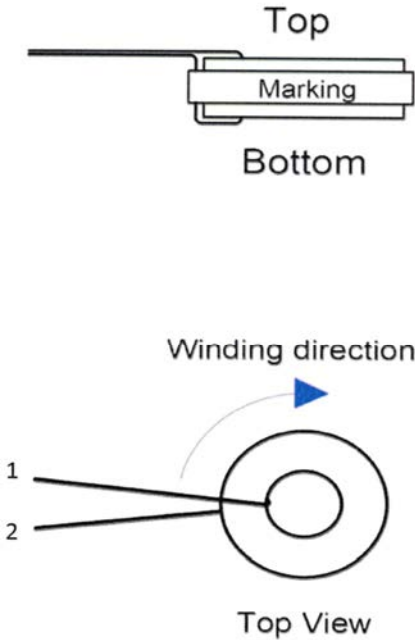
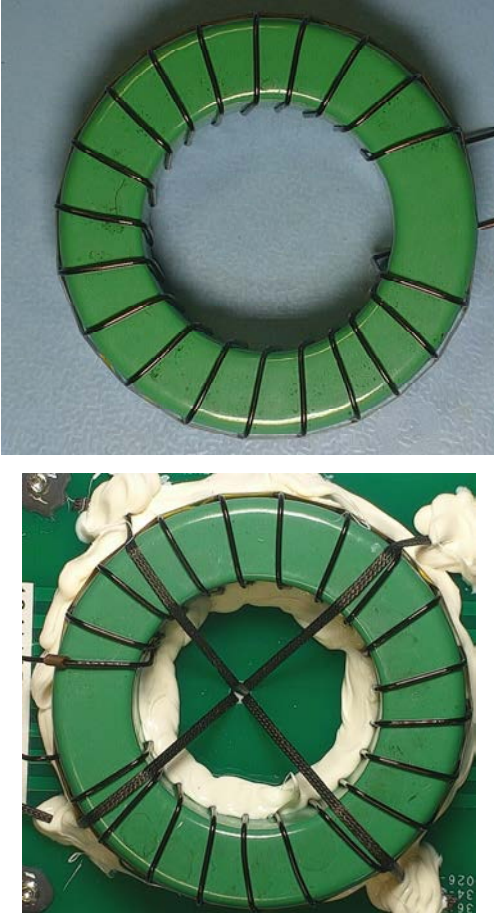
Part Outline	Part Mounting	Comments
<p data-bbox="383 237 539 261">Part Outline</p>  <p data-bbox="490 355 562 387">Top</p> <p data-bbox="490 427 584 451">Marking</p> <p data-bbox="472 499 602 531">Bottom</p> <p data-bbox="394 691 645 715">Winding direction</p> <p data-bbox="232 815 248 839">1</p> <p data-bbox="232 874 248 898">2</p> <p data-bbox="465 962 607 994">Top View</p>	<p data-bbox="1151 237 1339 261">Part Mounting</p> 	<p data-bbox="1809 237 1957 261">Comments</p> <ul data-bbox="1697 284 2018 467" style="list-style-type: none"> • FT 04980948-1 • 12411057-1-P • Inductor • Edge Core 59109 • Passive Life Test (120°C) • 500G Mechanical Shock • Random Vibration

12.27 Q27 – 12141123-1-P

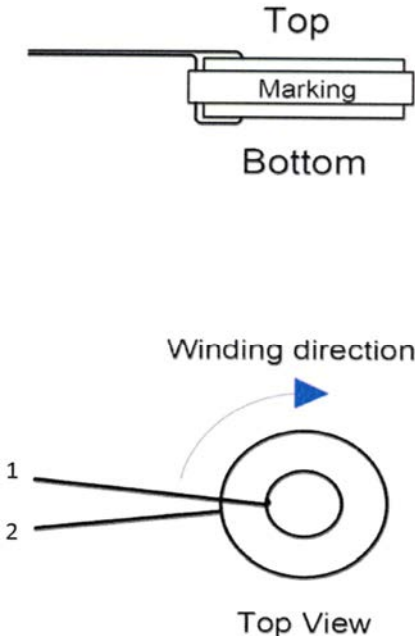
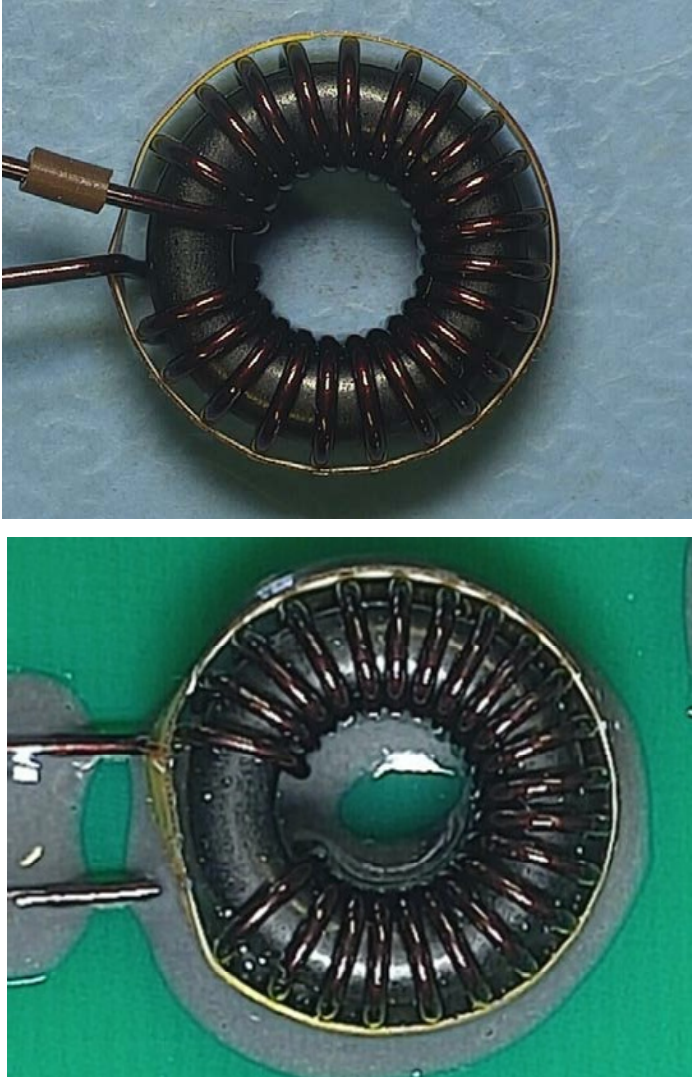
Part Outline	Part Mounting	Comments
<p data-bbox="383 236 544 261">Part Outline</p>  <p data-bbox="490 355 562 387">Top</p> <p data-bbox="490 427 584 453">Marking</p> <p data-bbox="472 499 602 531">Bottom</p> <p data-bbox="394 687 645 713">Winding direction</p> <p data-bbox="232 815 248 831">1</p> <p data-bbox="232 874 248 890">2</p> <p data-bbox="465 963 607 989">Top View</p>	<p data-bbox="1151 236 1339 261">Part Mounting</p> 	<p data-bbox="1809 236 1957 261">Comments</p> <ul data-bbox="1697 284 2018 464" style="list-style-type: none"> • FT 04980947-1 • 12141123-1-P • Inductor • Kool Mμ Ultra 70051 • Passive Life Test (120°C) • 500G Mechanical Shock • Random Vibration

12.28 Q28 – 12011044-1-P

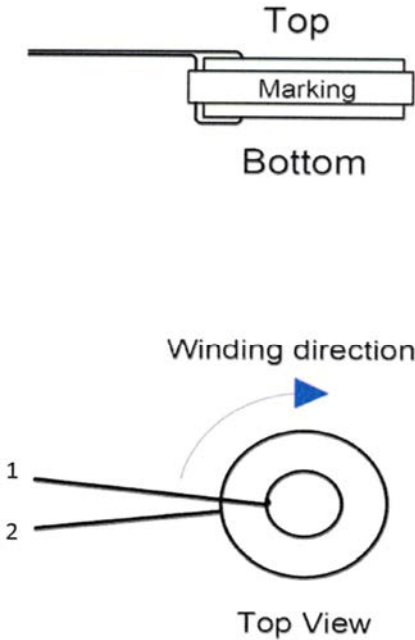
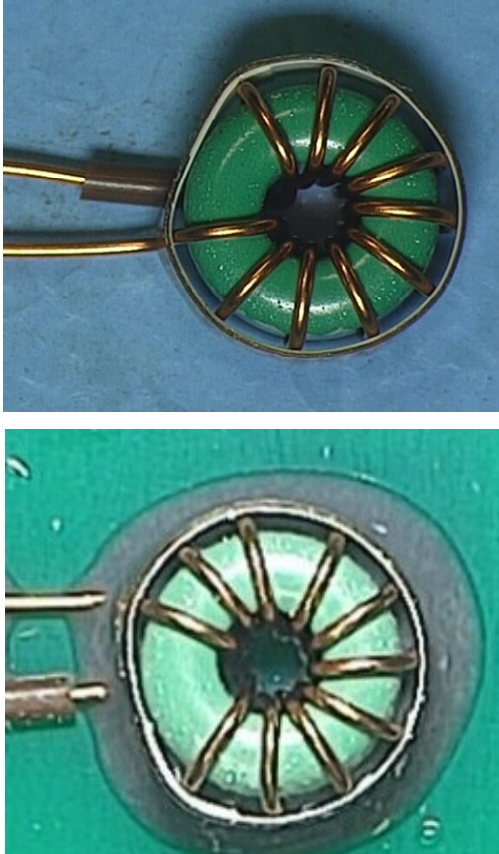
Part Outline	Part Mounting	Comments
<p data-bbox="383 236 539 261">Part Outline</p>  <p data-bbox="490 352 562 387">Top</p> <p data-bbox="490 424 584 450">Marking</p> <p data-bbox="472 496 602 521">Bottom</p> <p data-bbox="394 687 645 713">Winding direction</p> <p data-bbox="232 810 248 836">1</p> <p data-bbox="232 874 248 900">2</p> <p data-bbox="465 962 607 987">Top View</p>	<p data-bbox="1151 236 1339 261">Part Mounting</p> 	<p data-bbox="1809 236 1957 261">Comments</p> <ul data-bbox="1697 284 2018 464" style="list-style-type: none"> • FT 04980946-1 • 12011044-1-P • Inductor • Edge Core 59021 • Passive Life Test (120°C) • 500G Mechanical Shock • Random Vibration

12.29 Q29 – ESCC320101301F12939014-1-C

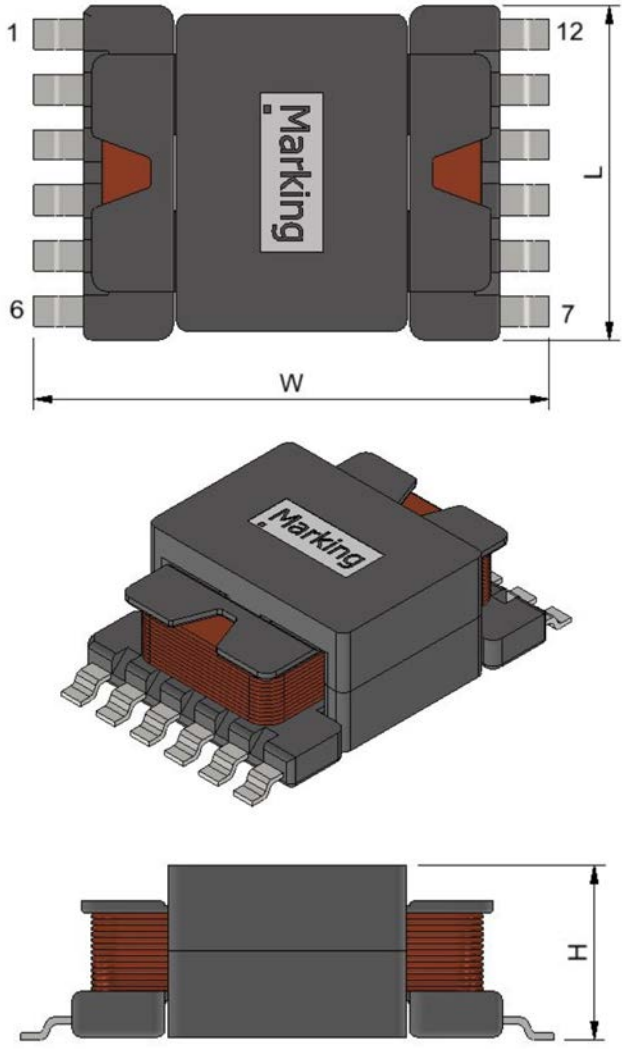
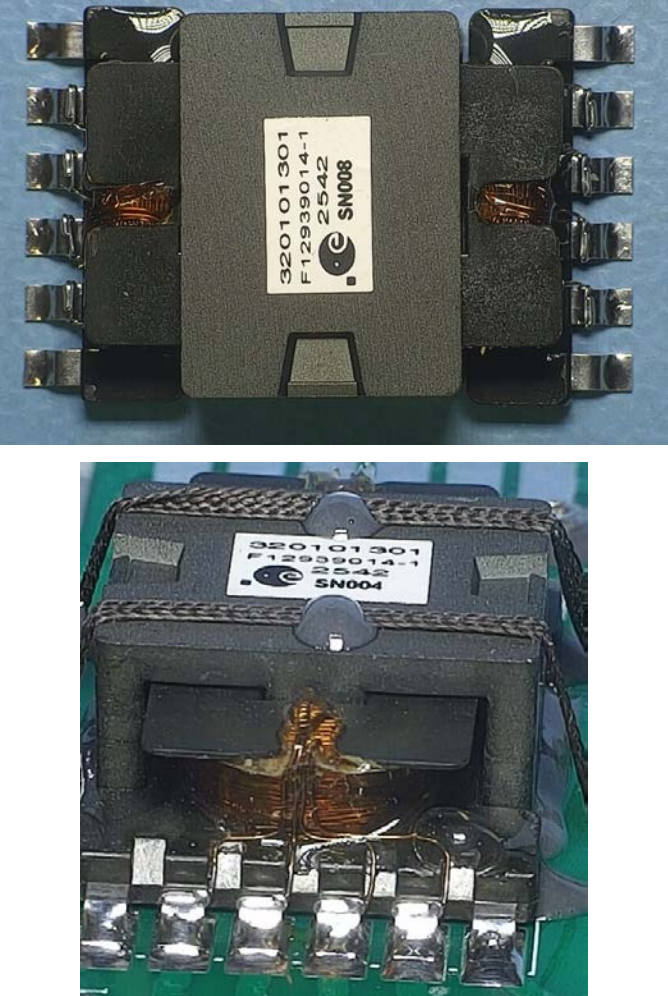
Part Outline	Part Mounting	Comments
		<p>Comments</p> <ul style="list-style-type: none"> • Magnetics Sheet 05000451-1 • ESCC320101301F12939014-1 • E22L Inductor Serie • EE22/6/16 3F46 • Passive Life Test (120°C) • 500G Mechanical Shock • Random Vibration

12.30 Q30 – 19210136-1-B

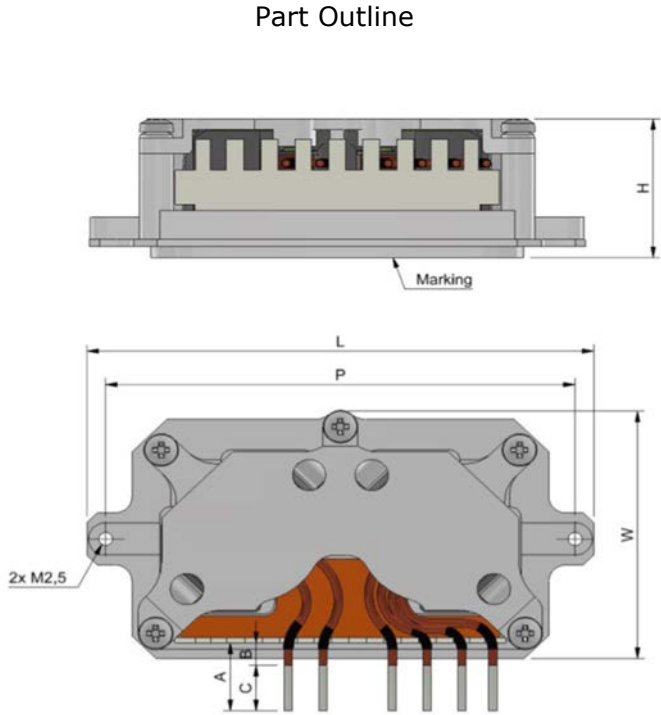
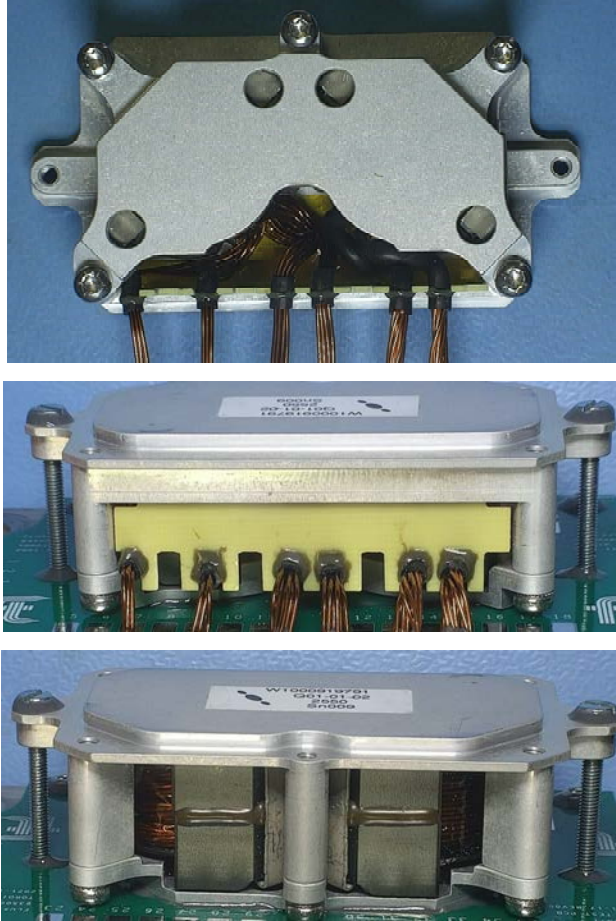
Part Outline	Part Mounting	Comments
 <p>Technical drawing of the part showing side and top views. Dimensions include L (length), P (width), W (height), H (total height), A, B, and C (distances from the bottom edge to the wires). A marking is indicated on the side view. The top view shows 2x M2.5 mounting holes.</p>	 <p>Three photographs showing the part mounted on a PCB. The top photo shows the top view of the assembly with wires. The middle photo shows the side view of the assembly. The bottom photo shows the bottom view of the assembly.</p>	<p>Comments</p> <ul style="list-style-type: none"> • 12241104-*C & 14241042-*C • 19210136-1-B • CMGE RM10 Assembly • 3C95 • Passive Life Test (120°C) • 500G Mechanical Shock • Random Vibration

12.31 Q31 – 14110323-1-B (CV10-2500) Pending

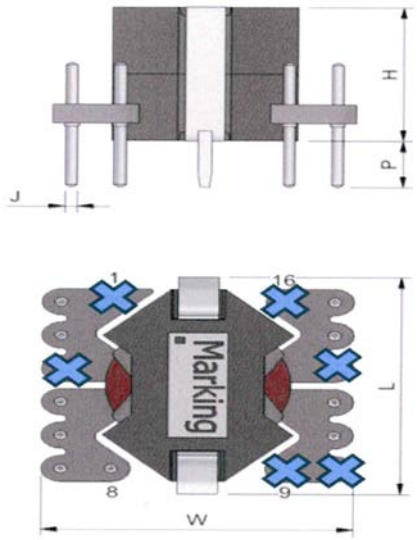
Part Outline	Part Mounting	Comments
		<ul style="list-style-type: none"> • FT 07530758-1 • 14110323-1-B • RM5 Flyback Transformer • PC95 • Passive Life Test (120°C) • 500G Mechanical Shock • Random Vibration

12.32 Q32 – 14110323-1-B (Arathane 5750) Pending

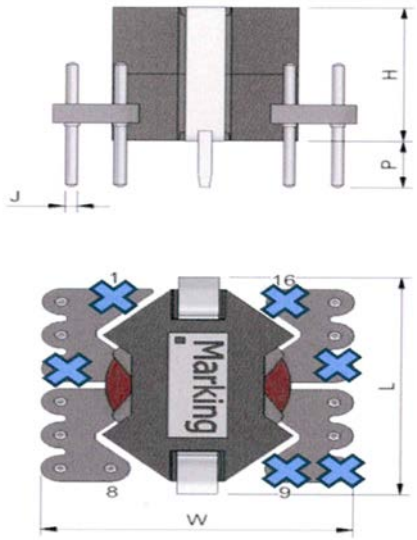
Part Outline	Part Mounting	Comments
		<ul style="list-style-type: none"> • FT 07530758-1 • 14110323-1-B • RM5 Flyback Transformer • PC95 • Passive Life Test (120°C) • 500G Mechanical Shock • Random Vibration